



Black anodized aluminium ■
Natural anodized aluminium ■

WMB 817 / WMB 818 Locking actuator



Natural ventilation



Smoke ventilation
EN 12101



Smoke ventilation
B300

24V

±24V control



MotorLink®



TrueSpeed™

5.40

Description

- for comfort and smoke ventilation
- locking actuator for windows with espagnolette system
- to be surface mounted or concealed
- discreet and slim line design
- to be used together with ±24V control units or control units with MotorLink®
- complete integrated system solution in combination with actuator WMX 814
- 3 speeds when using control unit with MotorLink®, TrueSpeed™ capable
- soft close
- built-in electronic load switch-off/end stop
- electronic actuator with micro controller
- cable connection available – no need for junction box
- easy mounting

Compact 24 VDC locking actuator, which automatically locks/opens the espagnolette system on the window, in such a way that the CE approval of the window is maintained. This unit can also be used for increased protection against weather or break in.

Closing force of 2000N per locking actuator.

The locking actuator is fitted on windows with an espagnolette system without handles, together with electric window actuators with MotorLink®.

The locking actuator can be surface mounted on or concealed in aluminium, timber or plastic window frames.

The espagnolette system can be set in two positions: locked/open.

The bracket is supplied with the locking actuator.

Actuator variants

The locking actuator is available in single and double version, meaning up to two locking actuators can be mounted on the same window.

Both the single and the double version can be used with up to four window actuators on the same window.

Single WMB (one WMB)

WMB 817-1 L: single, locking to the left

WMB 817-1 R: single, locking to the right

Double WMB (two WMB on the same window)

WMB 817-2 L: double, first WMB, locking to the left

WMB 817-2 R: double, first WMB, locking to the right

WMB 818-2 L: double, second WMB, locking to the left

WMB 818-2 R: double, second WMB, locking to the right

Technical data	
Pressure force / load	300N
Tractive force	300N
Closing force	2000N (break in force)
Speed	1 - 8mm/s, TrueSpeed™
Window types	top, bottom and side hung windows
Nominal voltage	24 VDC (max. 10% rippel)
Voltage	19 - 32 VDC
Open circuit voltage	max. 32 VDC
Current consumption	max. 1A
Power consumption	max. 24W
Temperature	-5°C - +74°C, max. 90% relative humidity (not condensing)
Switch on duration	ED 40% (2min. per 5min.)
Material	anodized aluminium grey actuators: grey silicon cable black actuators: black silicon cable
Colour	anodized natural aluminium and anodized black aluminium. Other RAL colors available at additional price.
Dimension	369 x 25 x 36,5mm (L x H x D)
Weight	0,96 kg
Connection	5 m, 3-core 0.34mm ² silicone cable with connector
IP rating	Surface mounted: IP 20, concealed: IP 32
SHE test	Approved according to EN 12101-2 with selected profiles – please contact WindowMaster for further information B300 tested according to EN 12101-2
Lifetime	11,000 open and close movements, full stroke
Delivery includes	locking actuator with 5m cable with fast-in / fast-on stick and bracket
Note	We reserve the right to make technical changes.

Combination options (here shown with WMX 814-n window actuator)

WMB 817-1 WMX 814-1



WMB 817-1 single locking actuator with one window single actuator

WMB 817-2 WMB 818-2 WMX 814-1



WMB 817-2 + WMB 818-2 double locking actuators with one single window actuator

WMB 817-1 WMX 814-4 WMX 814-4 WMX 814-4 WMX 814-4

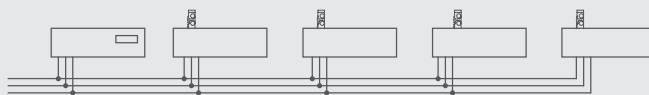

WMB 817-1 single locking actuator with up to four quad window actuators

WMB 817-2 WMB 818-2 WMX 814-4 WMX 814-4 WMX 814-4 WMX 814-4



WMB 817-2 + WMB 818-2 double locking actuators with up to four quad window actuators

WLL connection cable is to be ordered separately

Item code composition

WMB 817 / 818	-n	X	Y	Z	1
					Product version: 1
					Certification: E = CE + EN 12101-2
					Colour: B = Black, G = Grey
					Locking direction: L = Left, R = Right
Actuator variant: 1= Single, 2 = Double					

Explanation of product code structure

WMB 817-2LB E1 WMB 817 locking actuator, double variant, locking to the left (seen from the inside), CE and EN 12101-2 certification, product version 1

Items

Variant	Color	Description	Item no.
Single actuator	Grey	Single, locking to the left	WMB 817-1LG E1
		Single, locking to the right	WMB 817-1RG E1
	Black	Single, locking to the left	WMB 817-1LB E1
		Single, locking to the right	WMB 817-1RB E1
Double actuator	Grey	Double, first actuator, locking to the left	WMB 817-2LG E1
		Double, first actuator, locking to the right	WMB 817-2RG E1
		Double, second actuator, locking to the left	WMB 818-2LG E1
		Double, second actuator, locking to the right	WMB 818-2RG E1
	Black	Double, first actuator, locking to the left	WMB 817-2LB E1
		Double, first actuator, locking to the right	WMB 817-2RB E1
		Double, second actuator, locking to the left	WMB 818-2LB E1
		Double, second actuator, locking to the right	WMB 818-2RB E1

Accessories

	Item no.
Actuator bracket for WMB 817 / 818	WAB 817A
Espagnolette bracket for WMB 817 / 818	WAB 817C

Installation suggestion 1 - Inward opening

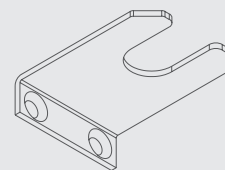
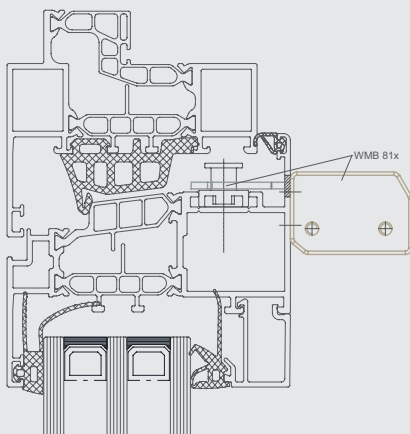

Bracket included with the actuator

Installation suggestion 2 - Outward opening

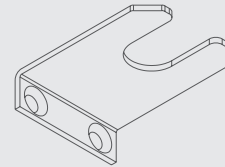
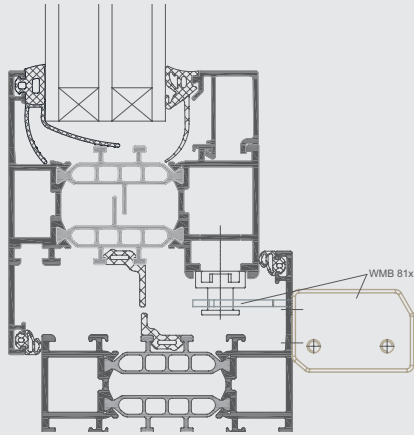

Bracket included with the actuator

Installation suggestion 3 - Inward opening

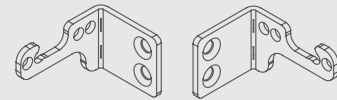
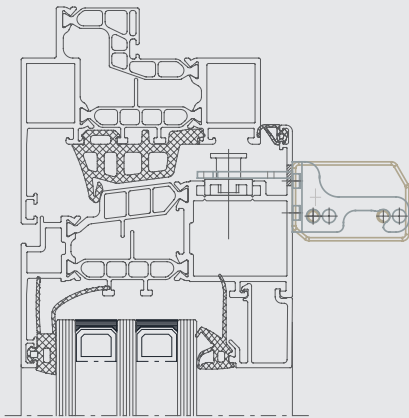

WAB 817A

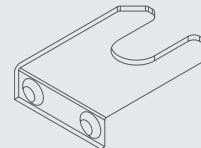

Bracket included with the actuator

Installation suggestion 4 - Outward opening

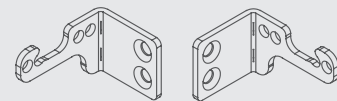
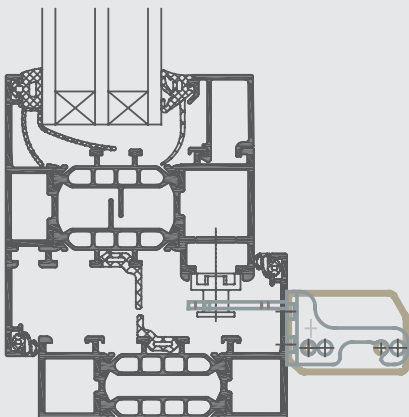

WAB 817A

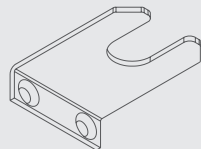

Bracket included with the actuator

WMB 817 / WMB 818

Locking actuator

Installation suggestion 5 - Inward opening

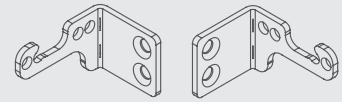
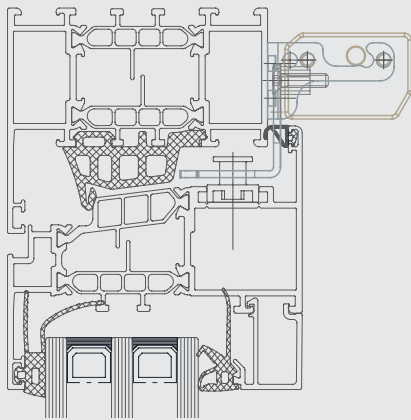

WAB 817A

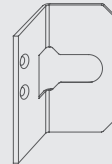

WAB 817C

