

WSC 310 & WSC 320 Plus versions

Installation instruction
(version 2407)

CompactSmoke™



For firmware version from:

Smoke panel version	Main card	Motor card
E1 and E5	1.43	2.13
E2, E4 and E6	2.15	2.13

Save this installation instruction to the end user

The latest version of this document can always be found on our web pages

UK
IE
Other markets

+44 (0) 1536 614 070
+353 (0) 1903 9455
+45 4567 0300

Info.uk@windowmaster.com
Info.ie@windowmaster.com
Info.dk@windowmaster.com

www.windowmaster.com

1	Safety information	4
1.1	Safety	4
1.2	230V AC	4
1.3	Back-up batteries	4
1.4	Application	4
1.5	Cable routing and electrical connection	4
2	Structure of the smoke panel	5
2.1	ISO 21927-9 related data	6
2.1.1	Access levels	7
3	Variants of panels	7
3.1	CompactSmoke™ Plus versions	7
3.2	Max numbers of actuators per motor line and panel	8
4	NV Embedded®	9
5	Accessories and spare parts	9
6	Technical data	10
7	Mounting	12
8	Installation	12
8.1	Cable routing	12
8.2	Cables into housing	12
8.3	Connection of safety earth wire and 230V AC	12
8.4	Installation of the break glass unit, ventilation keypad and smoke detector	12
8.5	Assembly instructions	13
9	Cable dimensioning	13
9.1	Maintaining the cable functions	13
9.2	Max. cable Length	13
9.2.1	Formula for the calculation of the maximum actuator cable length	13
9.2.2	Max cable length – ±24V standard actuators	14
9.2.3	Max cable length – actuators with MotorLink®	14
9.2.4	Max cable length – Pyrotechnic gas generator	15
10	Cable plan for connection to WSC 310 / 320 Plus version	16
11	Description of cards and mains connection	17
11.1	WSC 310 mains connection and power supply unit (WCA 3P1)	17
11.2	WSC 320 mains connection and power supply unit (WCA 3P2)	17
11.3	Connections between cards	18
11.4	Main control card WCA 3SP – Plus Version	18
11.5	Motor line card – WCA 3M8	29
11.6	Keypad card – WCA 3KI	30
11.7	Fieldbus cards	30
12	Cable monitoring of actuators	31
12.1	Usage of non-WindowMaster actuators	31
13	Back-up batteries	31
13.1	Measurement of battery charging voltage	32
14	Touch screen	32
14.1	Icons	32
14.2	Rotation of the touch screen	33
15	Configuration – main menu	33
15.1	Motor lines – motor groups – smoke zones	33
15.1.1	Examples with motor lines / motor groups / smoke zones	33
15.2	Motor line	34
15.2.1	Motor line - numbering	34
15.2.2	Motor line - configuration	34
15.2.3	Colour code - motor line	36
15.3	Motor group	36
15.3.1	Motor group - configuration	36
15.3.2	Colour code – motor group	36
15.4	Break glass unit	36
15.4.1	Break glass unit configuration	36
15.4.2	Colour code – break glass / WSK-Link™ unit	38
15.5	Smoke zone	38
15.6	Local input	39
15.6.1	Numbering of local inputs	39
15.6.2	Local input - configuration	40
15.6.3	Usage of wind/rain sensors - WLA 33x	41
15.7	Local output	42
15.7.1	Numbering of local output	43
15.7.2	Local output - configuration	43
15.8	Weather station type	44
15.9	Sequence control	44
15.10	Magnetic clamp (magnetic door retainer)	45
15.11	Pyrotechnic gas generator	46

15.12	Master / Slave connection of smoke zones	46
15.13	Network	49
15.13.1	AOnet	50
15.14	Log in	50
15.15	Configuration files on USB	51
15.16	System	51
15.16.1	Service timer	52
15.17	Fieldbus (KNX and BACnet)	53
15.17.1	KNX configuration	53
15.17.2	BACnet configuration	54
16	Status – main menu	54
17	Manual operation – main menu.....	54
18	Configuration missing – main menu	55
19	Hardware error – main menu.....	55
19.1	Error on the Power supply	55
19.1.1	Blown battery fuse – 20A fast.....	56
19.1.2	Voltage drop on the vBAT and replacement.....	56
20	View all details – main menu.....	57
21	Remote control of CompactSmoke™	57
22	Commissioning and test run.....	58
22.1	The control ventilation panel is completely installed, without the operating voltage applied.....	58
22.2	With mains voltage, without accumulator	58
22.3	With mains voltage, with accumulator	58
22.4	Ventilation keypad.....	58
22.5	Break glass unit WSK 50x.....	58
22.6	Smoke detectors	59
22.7	Emergency power supply test	59
22.8	Wind/rain detector	59
23	Maintenance	59
23.1	Maintenance agreements.....	59
23.2	Replacement cards	60
23.2.1	Replacement of 3M8 and 3KI cards	60
23.2.2	Replacement of 3SP card	60
24	Declaration of Conformity and Declaration of Performance	60

1 Safety information

1.1 Safety

Only allow correspondingly trained, qualified and skilled personnel to carry out installation work.

Reliable operation and the avoidance of damage and hazards are only guaranteed if installation and settings are carried out carefully in accordance with these instructions.

There may be personal danger by electrically operated windows:

- the forces occurring in the automatic mode can be such that parts of the body could get crushed
- when opened, actuators (spindles) could protrude into the room

For this reason, measures have to be taken prior to starting up the actuators, which exclude the danger of injury.

For safety reasons we recommend to install opening restrictors on bottom-hung windows.

If windows are subjected to rain and/or high wind loads, we recommend connecting a wind/rain sensor to the smoke ventilation panel for the automatically closing of the windows.

The smoke ventilation panel is to be located in a safe place, protected from the effects of fire and smoke.

The smoke ventilation panel is to be surface mounted.

The smoke ventilation panel has two energy suppliers: 230V AC and back-up batteries.

The manufacturer does not assume any liability for possible damage resulting from inappropriate use.

1.2 230V AC

230V AC can cause death, severe injury or considerable damage to assets.

The connection of the smoke ventilation panel is reserved for qualified personnel.

Disconnect all poles of the panel from the supply voltage prior to opening, installation or assembling.

Installation and use according to the national regulations.

1.3 Back-up batteries

Back-up batteries 2 batteries per panel can cause severe injury or considerable damage to assets.

The connection of the smoke ventilation panel is reserved for qualified personnel.

Disconnect all poles of the panel from the back-up batteries prior to installation or assembling.

Ensure that the mains cable can be switched via an external or customer-supplied two-pole switch element or a switch element controlling all poles – see section 7.1 “Cable routing”.

Installation and use according to the National regulations.

Dispose of used batteries according to the National regulation.

CAUTION

RISK OF EXPLOSION IF BATTERIES ARE REPLACED BY AN INCORRECT TYPE.

1.4 Application

The smoke ventilation panel is exclusively designed for the automatic opening and closing of smoke extraction systems, windows, flaps or doors.

Always check that your system meets the valid national regulations.

Pay particular attention to the opening cross section, the opening time and opening speed.

The cable cross sections depend on the cable length and current consumption (amperage).

1.5 Cable routing and electrical connection

Fuse the 230VAC power supply cable separately on site.

Cable routing and connection - adhere to national regulations.

Establish the cable types, if necessary, with the local approval bodies or the fire protection authority.

Do not conceal flexible cables.

Junction box must be accessible for maintenance purposes.

Disconnect all poles of the mains voltage and the back-up batteries prior to starting maintenance work or making changes to the system.

Secure the system to prevent unintentional switching on again.

Route all low voltage cables (24VDC) separate from the power current cables.

Design cable types, lengths, and cross sections in accordance with the technical information.

Cable specifications is a guide only, the overall responsibility resides with the electrical contractor on site.

Installation must be in accordance with the national electrical regulations.

2 Structure of the smoke panel

Sizes & Versions

The WSC 310 and WSC 320 smoke ventilation panels are available in two different versions namely a Standard and a Plus version. This installation instruction only deals with the Plus versions. Please see separate installation instruction for the Standard versions of WSC 310 and WSC 320.

Cards

Each panel contains a power supply unit (SMPS), either a WCA 3P1 or a WCA 3P2 for the 10A or 20A version respectively. Aside from the power supply unit the Plus version also includes a main control card type WCA 3SP, which includes a touch screen for easy configuration of the panel. Motor line and input cards, as well as fieldbus cards, can be added to the panel depending on requirements.

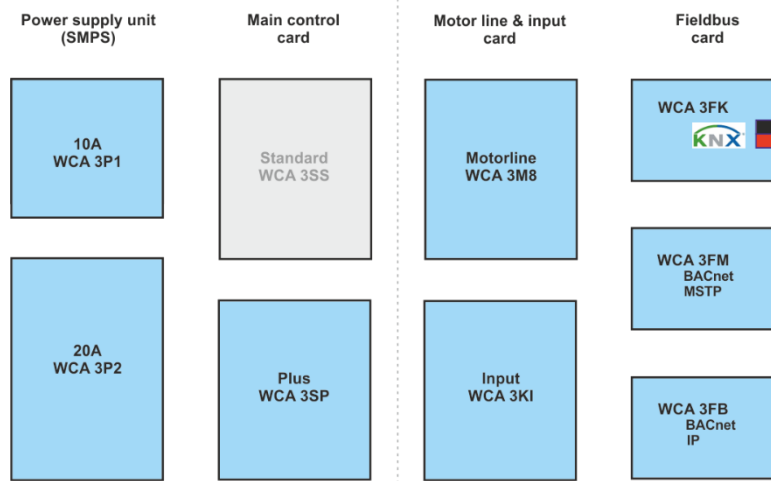

Selection of cards

The Main control card type WCA 3SP allows connections of 2 motor lines and 2 keypads. If more than 2 motor lines or 2 keypads are required, the necessary cards can be added.

Cards:

- WCA 3M8 motor line card, allows additional 8 motor lines.
- WCA 3KI input card, allows additional 10 keypads (requires WCA 3M8).

A fieldbus card must be added, if communication via KNX or BACnet is required.

Fieldbus cards:

- WCA 3FK fieldbus card, fieldbus interface for KNX
- WCA 3FM fieldbus card, fieldbus interface for BACnet / MSTP
- WCA 3FB fieldbus card, fieldbus key for BACnet IP

Installation of cards may only be done when there is no power on the panel (no battery or power on). Motor line and input cards are ordered together with the panel and mounted to the panel from the factory side, whereas the fieldbus cards are delivered as individual products and are to be mounted by the customer – see separate installation manual for mounting of fieldbus card.

The item no. of the panel specifies the type and mounting of the cards - see "Variants of panels" for more information.

Motor groups and motor lines

A motor group consists of one or more motor lines and all the motor lines are operated simultaneously.

The motor lines on both the main control card (WCA 3SP) and the motor line card (WCA 3M8) can all be configured for either a $\pm 24V$ standard actuators or MotorLink[®] actuators. A motor group can contain motor lines with both $\pm 24V$ standard actuators and MotorLink[®] actuators, whereas a motor line only can have $\pm 24V$ standard or MotorLink[®] actuators connected.

Adding panels

The smoke ventilation installation can be expanded by adding more panels and creating a master/slave connection among them. The master/slave connection is done directly on the WSA 3SP card. On the master panel the break glass inputs are used and on the slave panel the X11 input is used. The total cable length between 2 panels must not exceed 200m.

Break glass unit

Break glass unit type WSK 50x are to be used together with WSC 310/320. The units are configured and assigned to smoke zones via the touch screen on the main control card WCA 3SP.

Smoke zones

Up to 10 independent smoke zones can be implemented by the panel.

Inputs

Cabling

The WSC 3xx CompactSmoke™ uses bus technology and the overall cabling for break glass units, smoke detectors and keypads is significantly reduced compared to other types of smoke panels.

The main control card has 1 input for a smoke detector, 2 inputs for break glass units (where up to 10 break glass units can be connected) and 2 inputs for ventilation keypads (no max number of keypads).

Smoke detectors are either connected to the smoke detector input or to a break glass unit (type WSK 501 / 502).

The number of smoke zones and motor groups can be configured as required.

- max 2 smoke zones and 2 motor groups for a panel without motor line card.
- max 10 smoke zones and 10 motor groups for a panel with motor line card

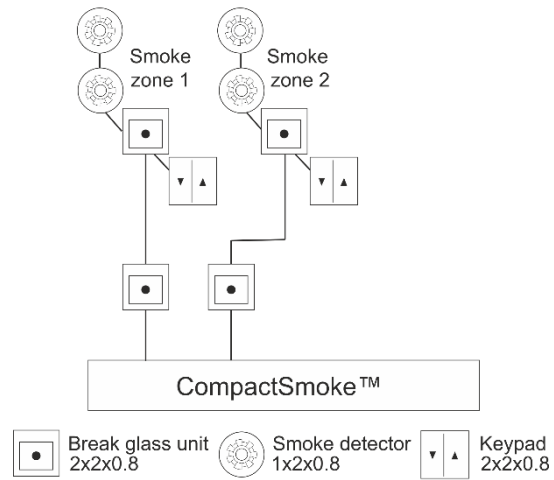

System example with WSC 320

Smoke ventilation panel (20A) motor line and keypad card configured in 2 smoke zones.

The keypads and smoke detector units are cabled directly to the break glass units in the smoke zones, which means that the need for cabling in the building is significantly reduced.

A wind/rain sensor is connected to close the windows during comfort ventilation in case of high wind and/or rain.

The smoke ventilation panel is connected to the Fire Alarm System via the WCA 3SP card.

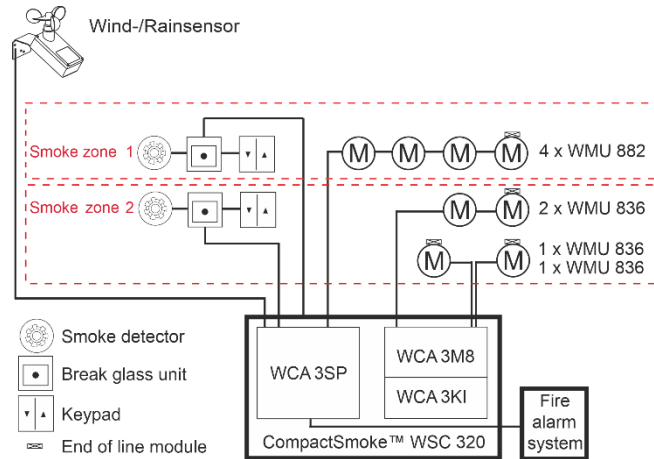

2.1 ISO 21927-9 related data

Panel version E4 and E6 is approved according to ISO 21927-9. The following optional indications, as defined in ISO 21927-9 clause 5 are included

- Audible indication
- Output to fire alarm
- Output to systems other than actuators
- Deadlock (type A) (reopening of windows every 2min for 30min)
- Co-incidence detection
- Dependency on more than one alarm signal
- Output of the fault conditions

The panel is an ISO 21927-9 Type D panel.

Minimum 1 break glass unit type WSK 5xx must be installed together with the panel, for the panel to conform with the ISO 21927-9 standard.

2.1.1 Access levels

Level	Access to	Who has access
1	<i>Public</i> You can see the smoke ventilation panel and break glass unit from the outside with the doors closed and locked	Everyone / General public
2	<i>Operation</i> You can open the break glass unit and reset the system	Chosen person e.g., building facility manger with a special key to break glass unit.
3	<i>Configuration</i> You can open the panel house and operate the touch screen for showing status, manual operating of the windows as well as configuration and changing the pre-set values. All the menus and sub menus can be seen, and the values can be changed. Access Level 3 can be locked with a PIN code, so there is only access to the level when the PIN is entered	Chosen persons with a special key and having the PIN code for access to level 3 / authorized to re-configure and service the panel e.g., a trained technician. PIN code pre-set to 4321.
4	<i>Maintenance</i> Administrative overall level: for operating as on access level 4 as well as updating with new software.	A trained technician, with access to the key to the panel, authorized by WindowMaster to upgrade the firmware of the panel and with a computer running the upgrading application, supplied by WindowMaster.

3 Variants of panels

Item composing									
WSC 3	xx		x		xx	xx		E	X
									x = Product version number For NV Embedded@ the smoke panel must be version 2, 4 or 6
									E = EN 12101-10
									<u>Input card*</u> 02 = No input card 12 = Input card (10 additional keypad inputs)
									<u>Motor line card</u> 02 = No motor line card 10 = Motor line card (8 additional lines)
									<u>Panel version</u> S = Standard P = Plus
									<u>Panel size</u> 10 = 10A 20 = 20A
Compact smoke series 3									

* Input card for keypads requires card for motor lines

3.1 CompactSmoke™ Plus versions

Number of motor lines and other functions	Cards	Item number
<i>Examples with WSC 310</i>		
Plus version 2 motor lines 2 keypads / inputs	No cards	WSC 310 P 0202 Ex
<i>Example with WSC 320</i>		
Plus version 2 motor lines 2 keypads / inputs	No cards	WSC 320 P 0202 Ex
Plus version 10 motor lines 12 keypads / inputs	1 x WCA 3M8 1 x WCA 3KI	WSC 320 P 1012 Ex

3.2 Max numbers of actuators per motor line and panel

The table shows the maximum number of actuators, which can be connected per motor line and panel depending on the type of the actuator, panel and connected card. The total power consumption of all the connected actuators must not exceed 10A for WSC 310 and 20A for WSC 320.

Actuator type	Per Motor line		Per 10A panel		Per 20A panel		
	± 24V actuators	MotorLink® actuators	± 24V actuators	MotorLink® actuators	± 24V actuators	MotorLink® actuators	
				2 motor lines		2 motor lines	10 motor lines
WMD 820-1	10	4	10	8	20	8	20
WMD 820-2	10	2	10	4	20	4	20
WMD 820-3	9	3	9	6	18	6	18
WMD 820-4	8	4	8	8	20	8	20
WMS 306-1	10	4	10	8	20	8	20
WMS 306-2	10	2	10	4	20	4	20
WMS 306-3	9	3	9	6	18	6	18
WMS 306-4	8	4	8	8	20	8	20
WMS 309-1	10	4	10	8	20	8	20
WMS 309-2	10	2	10	4	20	4	20
WMS 309-3	9	3	9	6	18	6	18
WMS 309-4	8	4	8	8	20	8	20
WMS 409 xxxx 01	5	0	5	0	10	0	0
WMS 409-1	5	4	5	4	10	8	10
WMS 409-2	4	2	4	4	8	4	10
WMS 409-3	3	3	3	3	9	6	9
WMS 409-4	4	4	4	4	8	8	8
WMU 831 / 836 / 851-1	10	4	10	8	20	8	20
WMU 831 / 836 / 851-2	10	2	10	4	20	4	20
WMU 831 / 836 / 851-3	9	3	9	6	18	6	18
WMU 831 / 836 / 851-4	8	4	8	8	20	8	20
WMU 861-1	8	4	8	8	16	8	16
WMU 861-2	8	2	8	4	16	4	16
WMU 861-3	6	3	6	6	15	6	15
WMU 861-4	8	4	8	8	16	8	16
WMU 842 / 852 / 862 / 882-1	4	4	4	4	8	8	8
WMU 842 / 852 / 862 / 882-2	4	2	4	4	8	4	8
WMU 842 / 852 / 862 / 882-3	3	3	3	3	6	6	6
WMU 842 / 852 / 862 / 882-4	4	4	4	4	8	8	9
WMU 863 / 883-1	2	2	2	2	6	6	6
WMU 863 / 883-2	2	2	2	2	6	4	4
WMU 863 / 883-3	0	0	0	0	6	6	6
WMU 863 / 883-4	0	0	0	0	4	4	4
WMU 864 / 884-1	2	2	2	2	4	4	4
WMU 864 / 884-2	2	2	2	2	4	4	4
WMU 864 / 884-3	0	0	0	0	3	3	3
WMU 864 / 884-4	0	0	0	0	4	4	4
WMU 885 / 895-1	2	2	2	2	4	4	4
WMU 885 / 895-2	2	2	2	2	4	4	4
WMU 885 / 895-3	0	0	0	0	3	3	3
WMU 885 / 895-4	0	0	0	0	4	4	4

	Per Motor line		Per 10A panel		Per 20A panel		
	± 24V actuators	MotorLink® actuators	± 24V actuators	MotorLink® actuators	± 24V actuators	MotorLink® actuators	
				2 motor lines		2 motor lines	10 motor lines
WMX 503 / 504 / 523 / 526-1	20	4	20	8	40	8	40
WMX 503 / 504 / 523 / 526-2	20	2	20	4	40	4	20
WMX 503 / 504 / 523 / 526-3	18	3	18	6	39	6	30
WMX 503 / 504 / 523 / 526-4	20	4	20	8	40	8	40
WMX 803 / 804 / 813 / 814 / 823 / 826-1	10	4	10	8	20	8	20
WMX 803 / 804 / 813 / 814 / 823 / 826-2	10	2	10	4	20	4	20
WMX 803 / 804 / 813 / 814 / 823 / 826-3	9	3	9	6	18	6	18
WMX 803 / 804 / 813 / 814 / 823 / 826-4	8	4	8	8	20	8	20
WML 820/825	10	0	10	0	20	0	0
WML 860-1	10	4	10	8	20	8	20
WML 860-2	10	2	10	4	20	4	20
WML 860-3	9	3	9	6	18	6	18
WML 860-4	8	4	8	8	20	8	20
WMB 801/802*	max. 4A connected to the WMB						
WMB 811/812 */**	10	2	10	4	20	4	20

* Do not exceed the total power consumption of the motor line

** When having two locking actuators per motor line, it must be one of each type: 1 x WMB 811 and 1 x WMB 812

4 NV Embedded®

The WSC 310 / 320 Plus Smoke panels (version 2, 4 or 6) can be used in an NV Embedded® indoor climate solution.

For further information about NV Embedded® and how to configure an NV Embedded® solution, please refer to the specific NV Embedded® documentation and the Appendix, which can be found on www.windowmaster.com.

5 Accessories and spare parts

Accessories	
Fieldbus card with field bus interface for KNX incl. cover – sold separately, not factory mounted	WCA 3FK
Fieldbus card with field bus interface for BACnet / MSTP incl. cover - sold separately, not factory mounted	WCA 3FM
Fieldbus card with field bus key for BACnet-IP incl. cover - sold separately, not factory mounted	WCA 3FB
Back-up battery for WSC 310 - 7Ah (2 x WSA 007 per panel)	WSA 007
Back-up battery for WSC 320 - 12Ah (2 x WSA 012 per panel)	WSA 012
Break glass unit, primary, with data communication, PVC housing. Has connection for possibility for comfort keypads and smoke detector. (x=colour of the housing: 1=red, 2=yellow, 3=grey, 5=orange) Only one unit per line	WSK 501 000x
Break glass unit, primary, with data communication, metal housing. Has connection for possibility for comfort keypads and smoke detector. (x=colour of the housing: 2=yellow, 3=grey, 5=orange) Only one unit per line	WSK 502 000x
Break glass unit, primary, with data communication, PVC housing. Has no connection possibility for comfort keypads and smoke detector. (x=colour of the housing: 1=red, 2=yellow, 3=grey, 5=orange)	WSK 503 000x
Break glass unit, primary, with data communication, metal housing. Has no connection possibility for comfort keypads and smoke detector. (x=colour of the housing: 2=yellow, 3=grey, 5=orange)	WSK 504 000x
Fireman override switch (only with panel version 2, 4 or 6)	WSK 510
Smoke detector	WSA 311
Indoor room sensor – temperature, relative humidity, and CO ₂	WWS 100

USB stick for NV Embedded® (only with panel version 2, 4 or 6)	NVE Dongle
USB stick for log-data, back-up, and firmware updates	WCA 304
Rain sensor	WLA 331
Rain/wind speed sensor	WLA 330
Rain/wind speed sensor, with pulse output	WLA 340
Weather station (only with panel version 4 or 6)	WOW 600
End of line motor module	WSA 510
End of line smoke detector module (10kΩ resistor), 10 pcs.	WSA 501
Fire alarm system cable surveillance module	WSA 306
Cable for wind and rain sensor WLA 340, 4m UV-resistant cable 4 x 2 x 0,75mm ²	WLL 604
Cables for smoke ventilation – see separate data sheet for further information	WLL 8xx
Cable glands for smoke panels	WSA 333
Spare parts	
10A power supply unit for WSC 310	WCA 3P1
20A power supply unit for WSC 320	WCA 3P2
Main control card for Plus version WSC 310 / WSC 320 incl. cover + 2 end of line modules (WSA 510)	WCA 3SP
Motor line card with 8 motor lines incl. cover + 8 end of line modules (WSA 510)	WCA 3M8
Input card with 10 inputs for e.g. key pads incl. cover (requires WCA 3M8)	WCA 3KI
Plastic covers for the cards in the WSC 310 /WSC 320 Plus version	WCA 301
Fieldbus card with fieldbus interface for KNX incl. cover	WCA 3FK
Fieldbus card with fieldbus interface for BACnet / MSTP incl. cover	WCA 3FM
Lock cylinder incl. 2 keys for WSC 310/320 panel	WSK 438
Replacement glass for break glass units type WSK 501 / 502 / 503 / 504, 5 pcs.	WSK 397
Keys for break glass units type WSK 501 / 503, 5 pcs.	WSK 398
Lockable replacement PVC housing for break glass unit x=colour of the housing: 1 = red, 2 = yellow, 3 = grey, 5 = orange	WSK 399 000x
Back-up battery cable kit for WSC 310 / 320 (cable between WCA 3SP / 3SS and the batteries and between the batteries)	WSA 330 0101
20A battery fuse. The battery fuse on the WCA 3SP/3SS, 10 pcs	WSA 331 0101

6 Technical data

Technical data	
Output current (nominal)	WSC 310: 10A / WSC 320: 20A
Secondary voltage	Voltage 24V DC (±15%) Open circuit voltage (no load) 27,6V DC @ 20°C Ripple at max load max. 6% (3,5Vpp)
Motor lines	WSC 310/320 0202: max 2, WSC 320 1012: max 10 A motor line can contain either ±24V standard motors or MotorLink® motors
Motor groups	WSC 310/320 0202: max 2, WSC 320 1012: max 10 Via the software more motor lines can be connected in the same group
Smoke zones	WSC 310/320 0202: max 2, WSC 320 1012: max 10
Primary voltage	WSC 310: 230V AC, 50Hz (85-264V AC, 47-63Hz) WSC 320: 230V AC, 50Hz (85-264V AC, 47-63Hz)

Power consumption	<p>WSC 310: min 3.2W¹⁺², typ. 4.8W¹⁺³. At max load 300W WSC 320: min 5.0W¹⁺², typ. 5,6W¹⁺³. At max load 600W</p> <p>1) no load: system operational but no actuators are running 2) min: 1 x break glass unit WSK 501 and 1 x smoke detector WSA 311 3) max load: 1 x break glass unit WSK 501, 4 x break glass unit WSK 503 and 10 x smoke detector WSA 311</p>	
Leakage current	Max 1.2mA @ 240VAC	
Inrush current on primary site	70A<5ms Max. 3 x WSC 310/320 per 10A supply group Circuit breaker "C" characteristic	
±24V change over time	min 500ms	
Back-up batteries	WSC 310: 2 x WSA 007 (12V / 7Ah) WSC 320: 2 x WSA 012 (12V / 12Ah) Expected lifetime max 4 years, only use genuine WindowMaster batteries	
Emergency power	>72 hours in accordance with EN 12101-10	
Automatic smoke triggering	Smoke triggering when the temperature inside the compact unit exceeds 72°C	
Charging unit (integrated in WCA 3SP card)	Charging voltage: 27,7 – 27,8V at 20°C Charging current: 1.7A, current limited	
Priority	Smoke signal has always highest priority	
Cable monitoring	±24V standard actuators with end of line module and smoke detectors are monitored by closed-circuit. Actuators with MotorLink® and break glass units are monitored by data communication. Back-up batteries are monitored by cyclic measuring	
LED message OK, fault and alarm	Green Yellow Red	all OK fault fire
Reopening the actuators	Every 2.min. in 30min. after a SHE open (selectable) Pre-set: <u>no</u> reopening	
Connection cable	Actuators Other components	flexible max 6 mm ² / solide max 10 mm ² min 0,2mm ² / max 1,5mm ²
Operating conditions	-5°C - +40°C, max. 95% relative humidity (not condensing) EN 12101-10: Operation class A, Environmental class 1, with IP value increased to IP 54 (according to EN 12101-10 is min. IP 30 required)	
Max actuator activation duration (duty cycle)	ED 40% (4min. per 10min.)	
Max allowed current drawn from the battery when the primary power source is disconnected	WSC 310: 10A WSC 321: 20A	
Max interruption time during switching between power sources	<2.0sec	
Break glass unit	Up to 10 break glass units type WSK 50x can be connected to the WCA 3PS, but only 1 WSK 501 / 502 per line, meaning max 2 WSK 501 / 502 per panel. Smoke detectors and ventilation keypads can only be connected to break glass units type WSK 501 / 502. Up to 10 smoke detectors can be connected to each WSK 501 / 502, and 10 smoke detectors can be connected to the smoke detector input on the main board, which give a total maximum of 30 smoke detectors. There is no limit on the number of ventilation keypads connected to the WSK 501 / 502. Smoke detectors and ventilation keypads <u>cannot</u> be connected to WSK 503 / 504.	
Number of motor lines per card	WCA 3SP WCA 3M8	2 x 10A motor line for ±24V standard or MotorLink® actuators 8 x 10A motor line for ±24V standard or MotorLink® actuators
Material	Metal housing for surface mounting	
Colour	Grey (RAL 7035)	

Size	WSC 310: 300 x 400 x 120mm (H x W x D) WSC 320: 300 x 400 x 210mm (H x W x D)
Weight	WSC 310: 6kg no batteries, 10.8kg with batteries (2 x WSA 007) WSC 320: 8.6kg no batteries, 16.6kg with batteries (2 x WSA 012)
Protection class	IP54
Approval / certification	All panel versions are approved and certified according to EN 12101-10 Panel version E4 and E6 is approved and certified according to ISO 21927-9
Delivery	CompactSmoke™ smoke ventilation panel with WSA 501 (10kΩ resistors, 10 pcs.) and 2 or 10 pcs. end of line module WSA 510. Back-up batteries included.
Note	We reserve the right to make technical changes

7 Mounting

The smoke ventilation panel is fixed to the wall through the Ø8.5mm holes in the back plane of the housing.

If the panel is fixed in different way, the holes are to be blinded with the 4 blind grommets, this way the IP class is maintained.

The door is turnable.

When turning the door also move the blind grommets to the new holes.

The smoke ventilation panel is to be located in a safe place, protected from the effects of fire and smoke.

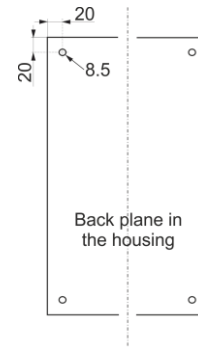

8 Installation

8.1 Cable routing

For cable routing, we recommend the use of fire protected cables retaining their function E90 or E30.

See also chapter 8 "Cable dimensioning" in this instruction.

However, this has to be agreed with the Engineer or, if necessary, with the local fire protection department.

Do not reduce the cable cross sections specified in the cable lengths table.

All cables of the control (except the mains supply cable) carry 24V DC and have to be routed separate from the mains supply cable.

Adhere to the pertinent national and local regulations when routing the cables.

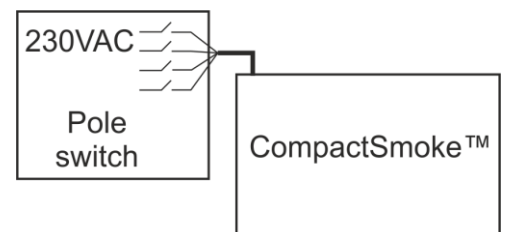

8.2 Cables into housing

All connection terminals (except the mains terminals) are of the plug-in type.

Connect the connection cables in accordance with the terminal plan. Ensure that the connections are made correctly.

Incorrect cable clamping, mixing up numbers or colours could lead to malfunctions of the control panel or of the external components.

Ensure that the electrical cables are always routed according to the valid national and local regulations.

8.3 Connection of safety earth wire and 230V AC

See chapter 10 'Description of cards', section 10 for further description.

8.4 Installation of the break glass unit, ventilation keypad and smoke detector

Ensure that the break glass unit and the ventilation buttons are visible and well accessible. Do not install behind protruding walls, door panels or hidden by the building structure.

Note: Installation height of the break glass unit 1.5 – 1.7m above floor.

Install the smoke detectors in accordance with their enclosed instructions.

8.5 Assembly instructions

Always have assembly, installation, repair and maintenance of smoke and heat extraction systems carried out by qualified personnel trained for this purpose.

Rules to be adhered to for setting up and installation

The following safety relevant rules have to be adhered to when planning the use of a smoke and heat extraction system and its set-up and installation:

- The Provincial Building Ordinance of the provinces,
- The regulations of the competent fire protection authority,

Accident prevention regulations

Adhere to the general accident prevention regulations (APR), the APR for power operated windows and doors, and the installation rules in your country.

CAUTION:

Live components are directly accessible after opening the system housing.

Prior to inserting / removing cards disconnect to the panel from the mains supply and the back-up batteries.

- adhere to the installation instructions and your local energy providers
- select the place of installation such that free access is guaranteed for maintenance purposes
- select cables according to regulations in this instruction - take the calculation of the actuators supply cable lengths into account when laying the cables
- power cables entered via the cable glands
- connect the cables in accordance with the drawings provided by the manufacturer
- route the cables in the building according to the regulations in this instruction
- after the smoke panel is installed the back-up batteries will be fully charged after ca. 8 hours
- check all system functions

Electric cable routing for smoke and heat extraction systems

Electrical cables always have to be laid in accordance with the national and local rules in your country.

Do not use the PE wire / green/yellow wire!

Cables of type NYM, concealed, can be used.

For surface laying, halogen free safety cables are recommended (see cable plan).

If possible, the use of cable types should be agreed with the Technical Services and the competent fire protection authority.

For the maximum permissible cable lengths of the actuator supply cables for the WSC 3xx system, taking the specified cable cross sections into account (cable information for surface laying), please refer to chapter 8 "Cable dimensioning".

9 Cable dimensioning

9.1 Maintaining the cable functions

According to valid national regulations.

The cable network for smoke ventilation systems ("Cable system") ends normally at the interface (junction box) for the actuator! The flexible, heat resistant connection cable of actuator is part of the system component, electric actuator actuation, and is not a part of the electrical installation!

We recommend in all cases to discuss the type of cable routing with the competent fire fighting authorities.

9.2 Max. cable Length

Maximum permissible cable length from the smoke ventilation panel to the actuators and pyrotechnic gas generator taking into account the cable cross-section is shown in the following tables for "± 24V standard actuators", "MotorLink® actuators" and "pyrotechnic gas generator".

9.2.1 Formula for the calculation of the maximum actuator cable length

$$\text{Max. cable length} = \frac{\text{permissible voltage drop } 2V \text{ (UL)} \times \text{conductivity of copper(56)} \times \text{cable cross section in mm}^2 \text{ (a)}}{\text{max. actuator current total in amps (I)} \times 2}$$

For both ±24V standard actuators and actuators with MotorLink® the cross section of the cable must not be less than 0.75mm² regardless of the result of above formula.

Maximum actuator cable length: Always measured from the smoke to the last junction box

Permissible max. voltage drop in the line: 2 Volt

Actuating current: Sum of all actuator power consumption per motor line

Note: do not use the PE wire / green/yellow wire!

Example

Max actuator cable length with cable cross section 0.75mm² and actuator current 2A: $(2 \times 56 \times 0.75) : (2 \times 2) = \underline{21\text{m}}$

9.2.2 Max cable length – ±24V standard actuators

The actuator supply cable must have 3 wires: 2 wires current carrying / 1 wire for monitoring.

±24V standard actuators						
Do not use the PE wire / green/yellow wire!						
cable cross section [a]	3-wire 0.75mm²	3-wire 1.50 mm²	5-wire 1.50 mm² 2 wire parallel	3-wire 2.50 mm²	5-wire 2.50 mm² 2 wire parallel	3-wire 4.00 mm²
Total actuator current [I]						
1A	42m	84m	168m	140m	280m	224m
2A	21m	42m	84m	70m	140m	112m
3A	14m	28m	56m	47m	93m	75m
4A	11m	21m	42m	35m	70m	56m
5A	8m	17m	34m	28m	56m	45m
6A	7m	14m	28m	23m	47m	37m
7A	6m	12m	24m	20m	40m	32m
8A	5m	11m	21m	18m	35m	28m
9A		9m	18m	15m	31m	25m
10A		8m	16m	14m	28m	22m
20A		4m	8m	7m	14m	11m

9.2.3 Max cable length – actuators with MotorLink®

The actuator supply cable must have 3 wires: 2 wires current carrying / 1 wire for communication.

When a 5-wire cable is used for MotorLink®

It is not recommended to use parallel-wire.

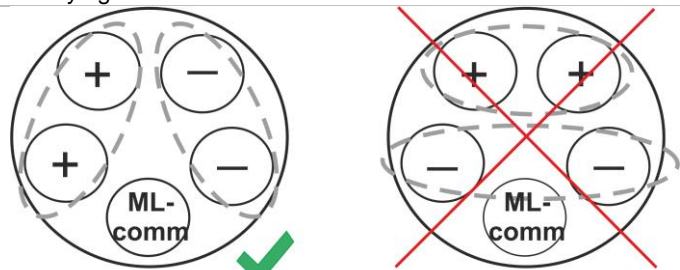

ML-comm = MotorLink® communication.

Furthermore, when using a 5-core cable, the distance between "-" and "Com" must be the same as the distance between "+" and "Com".

Meaning if L2 e.g. is being used as "Com" L1 and L3 must be used for "+" and "-".

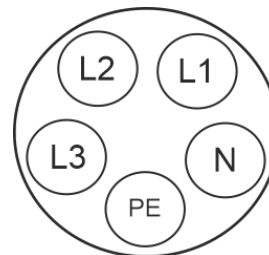

When using actuators with MotorLink® the max/total cable length is 50m regardless of the result of the above-mentioned formula.

Actuators with MotorLink®						
Do not use the PE wire / green/yellow wire!						
cable cross section [a]	3-wire 0.75mm ²	3-wire 1.50 mm ²	5-wire 1.50 mm ² 2 wire parallel	3-wire 2.50 mm ²	5-wire 2.50 mm ² 2 wire parallel	3-wire 4.00 mm ²
Total actuator current [I]						
1A	42m	50m				
2A	21m	40m	50m			
3A	14m	28m	50m	47m	50m	
4A	11m	21m	42m	35m	50m	
5A	8m	17m	34m	28m	50m	45m
6A	7m	14m	28m	23m	47m	37m
7A	6m	12m	24m	20m	40m	32m
8A	5m	11m	21m	18m	35m	28m
9A		9m	18m	15m	31m	25m
10A		8m	16m	14m	28m	22m
20A		4m	8m	7m	14m	11m

Definition of total cable length

The total cable length is defined as the sum of all cables from the MotorController output to the last actuator. Including the cable mounted on the actuator.

For example, in case of 4 actuators with 5m cable each, the remaining cable length is 30m.

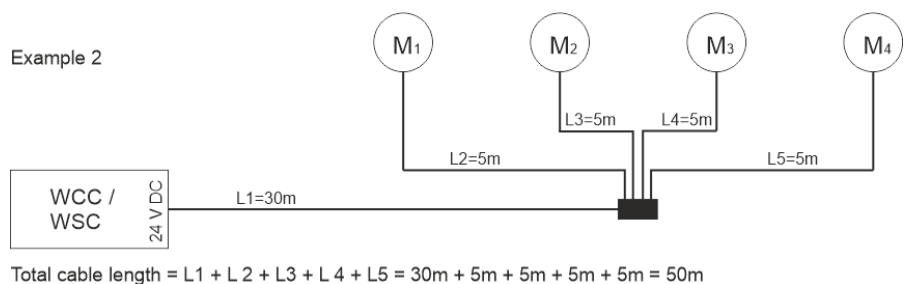
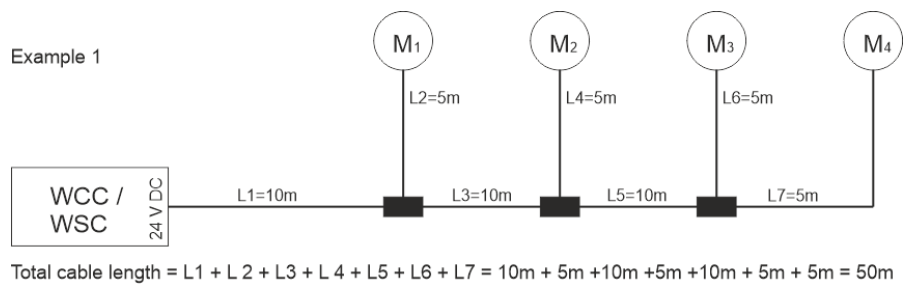

9.2.4 'Max cable length – Pyrotechnic gas generator

Pyrotechnic gas generator*						
Do not use the PE wire / green/yellow wire!						
cable cross section [a]	3-wire 0.75mm ²	3-wire 1.50 mm ²	5-wire 1.50 mm ² 2 wire parallel	3-wire 2.50 mm ²	5-wire 2.50 mm ² 2 wire parallel	3-wire 4.00 mm ²
Total actuator current [I]						
1A	42m	84m	168m	140m	280m	224m

*CompactSmoke™ has been tested with Chemring type 1.3.

10 Cable plan for connection to WSC 310 / 320 Plus version

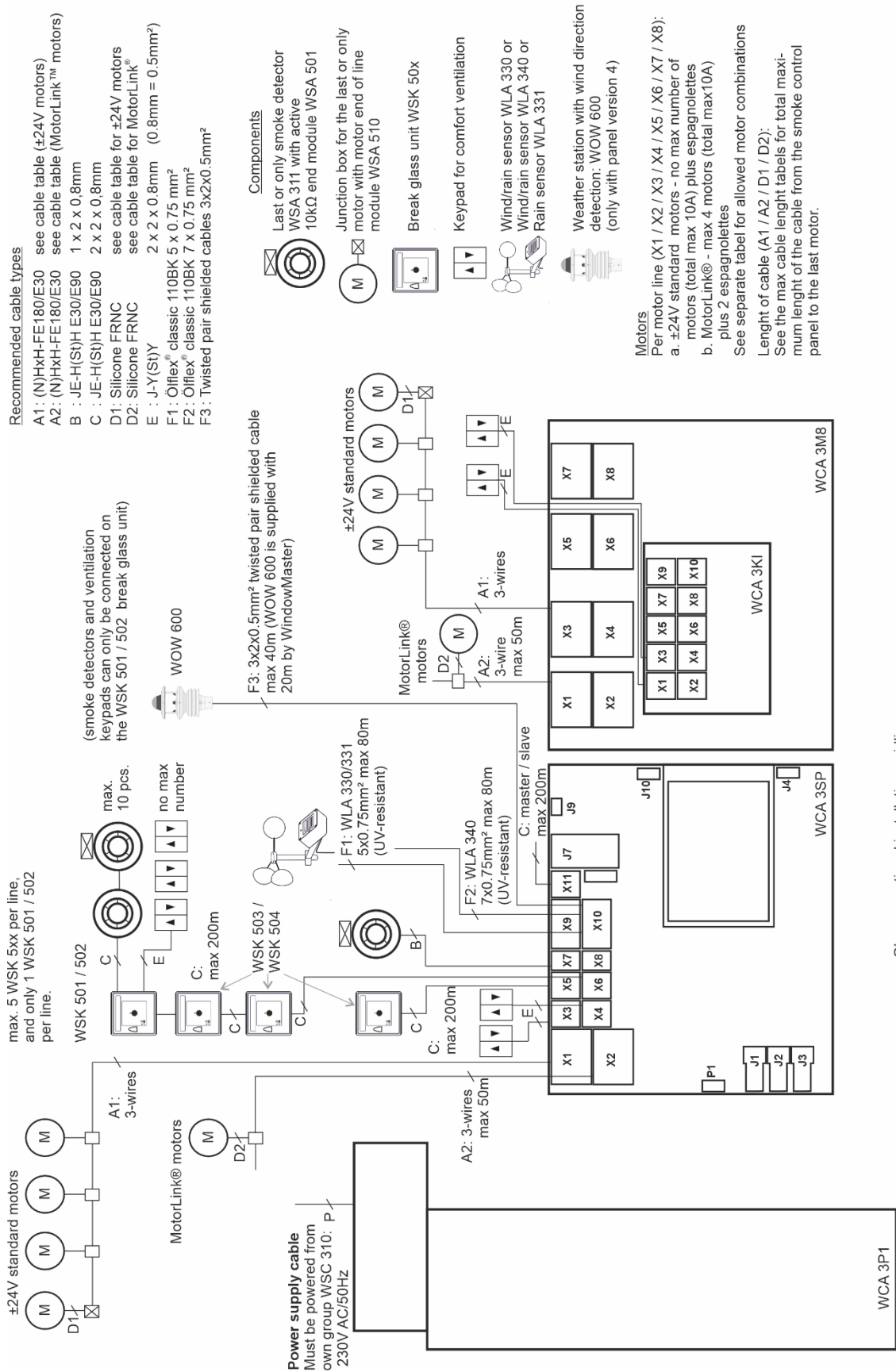

The above plan shows a WSC 310 panel, where the power supply unit is located in the left side of the panel wherefrom also mains is pulled. The power supply unit for the WSC 320 panel is located underneath the main control and motor line card and mains is pulled from the top right side. See section 11.1 for illustrations.

11 Description of cards and mains connection

Each panel includes a power supply unit (SMPS) and a main control card. Motor line can input cards for additional motor lines and inputs (e.g. for key pads) as well as a fieldbus card can be added when necessary.

The size of the power supply unit determines the size of the panel and the number and/or types of actuators, which can be connected to the panel. See table with overview of max number of allowed actuators per motor line/panel (chapter 3.2).

The size of the power supply also determines the physical design of the panel inside the cabinet and thereby eg. where mains is connected to the main control board (WCA 3SP).

11.1 WSC 310 mains connection and power supply unit (WCA 3P1)

<p>WSC 310 – WCA 3P1 With 300W SMPS unit</p> <p>The power supply is located to the left of the main control card.</p> <p>The cable inlet is in the top left corner of the panel.</p> <p>The panel must be grounded by means of protective earth on the top panel plate.</p>	<p>Mains</p> <p>Protective earth</p> <p>WCA 3P1</p> <p>WCA 3SP</p> <p>WCA 3M8</p> <p>WCA 3KI</p> <p>WCA 3P1</p> <p>J1: Connection for power supply</p> <p>J2: Connection for WCA 3M8</p> <p>J3: Connection for battery back-up</p> <p>WSA 007</p> <p>WSA 007</p>
	<p>PE</p> <p>230V</p> <p>L-N</p>

11.2 WSC 320 mains connection and power supply unit (WCA 3P2)

<p>WSC 320 - WCA 3P2 With 600W SMPS unit</p> <p>The power supply is located underneath the main control and the motor line card.</p> <p>The cable inlet is in top right corner of the panel.</p> <p>The panel must be grounded by means of protective earth on the top right side of the panel.</p>	<p>Mains</p> <p>Protective earth</p> <p>WCA 3P2</p> <p>WCA 3SP</p> <p>WCA 3M8</p> <p>WCA 3KI</p> <p>WCA 3P2</p> <p>J1: Connection for power supply</p> <p>J2: Connection for WCA 3M8</p> <p>J3: Connection for battery back-up</p> <p>WSA 012</p> <p>WSA 012</p>
	<p>230V</p> <p>PE</p> <p>L-N</p>

11.3 Connections between cards

An overview of how the different cards are connected are shown below.

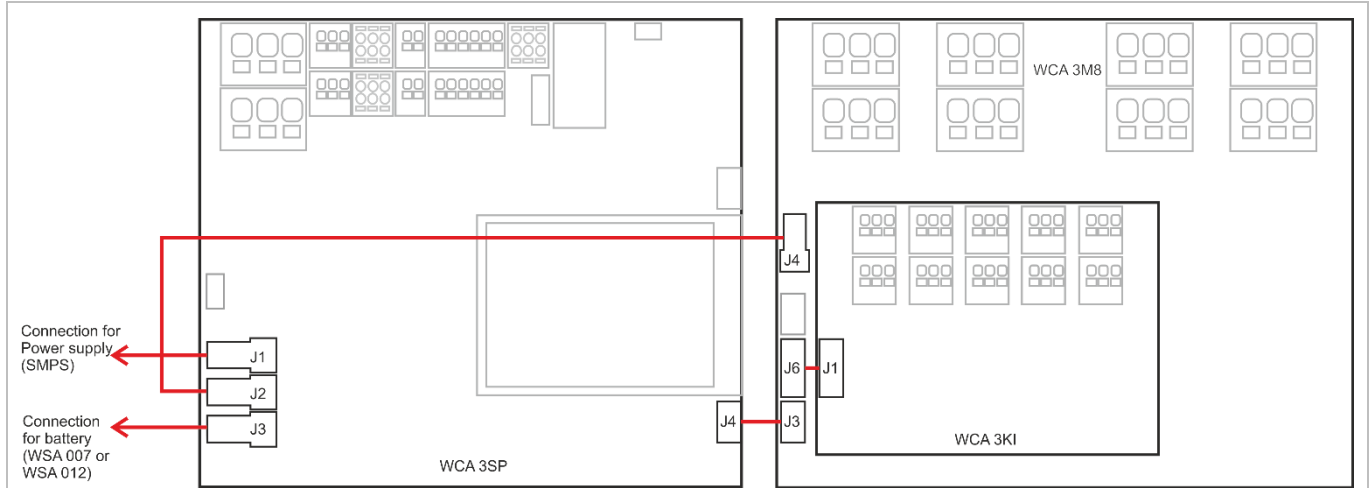

11.4 Main control card WCA 3SP – Plus Version

Each WCA 3SP contains the following:

- 2 motor lines for ±24V standard or MotorLink® actuators
- 2 input for keypads for comfort ventilation
- 2 input for break glass units
- 1 input for smoke detector
- 1 input for 24V/48V
- Output for fault signal to Fire Alarm System
- Input for weather station incl. wind direction (WLA 330 / 331 / 340 / WOW 600)
- Input for master / slave connection (ISO line)
- connection of power supply
- Power for motor line card
- Connection for battery back-up
- Connection for motor line card
- Two connections for Ethernet
- Connection for USB host and USB device
- Connection for fieldbus card
- Touch screen for configuration, commissioning and maintenance

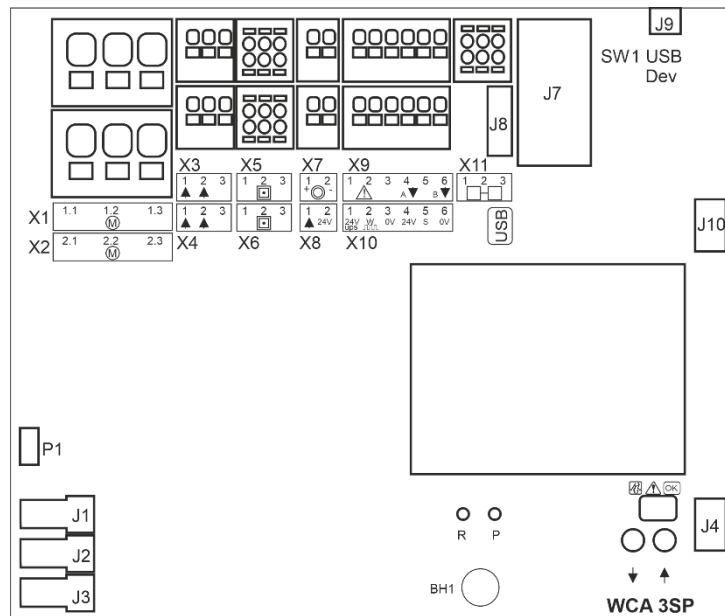

X1	1.1 24V / 0V 1.2 Cable monitoring / MotorLink® 1.3 0V / 24V	} Motorline	X10	10.1 24V UPS 10.2 Wind speed 10.3 GND / 0V 10.4 24V 10.5 Rain 10.6 GND / 0V	} Weather station with wind direction
X2	2.1 24V / 0V 2.2 Cable monitoring / MotorLink® 2.3 0V / 24V		X11	11.1 24V IN 11.2 Comm. 11.3 0V IN	
X3	3.1 Open 1.1 3.2 Close 1.2 3.3 GND / 0V	} Comfort key pad #1	J1	Power from power supply	
X4	4.1 Open 2.1 4.2 Close 2.2 4.3 GND / 0V		J2	Power to motor line card (WCA 3M8)	
X5	5.1 24V 5.2 Comm. 5.3 0V	} Break glass unit WSK 50x #1	J3	Battery pack connection	
X6	6.1 24V 6.2 Comm. 6.3 0V		J4	Connection for motor line card (WCA 3M8)	
X7	7.1 + 7.2 -	} Smoke detector WSA 311	J7	2 x ethernet	
X8	8.1 + 8.2 -		J8	USB host	
X9	9.1 Fault 9.2 Fault 9.3 Output A 9.4 Output A 9.5 Output B 9.6 Output B	} Output	J9	USB device	
			J10	Connection for fieldbus card	
			P1	Control for power supply	
			R / P	Reset / Programming	
			↓ ↑	Close and open all windows	
			BH1	VBAT, back-up battery for CPU and system clock	

X1 / X2

The WCA 3SP card has 2 motor lines (X1 and X2) for connection of $\pm 24V$ standard or MotorLink[®] actuators.

$\pm 24V$ standard actuators

- | | |
|----------------------|----------------------|
| 1.1 24V / 0V | 2.1 24V / 0V |
| 1.2 Cable monitoring | 2.2 Cable monitoring |
| 1.3 0V / 24V | 2.3 0V / 24V |

MotorLink[®] actuator

- | | |
|-------------------|-------------------|
| 1.1 0V | 2.1 0V |
| 1.2 Communication | 2.2 Communication |
| 1.3 24V | 2.3 24V |

The number of actuators per motor line depends on the actuator type, the total power consumption of actuators connected to a motor line can max be 10A and the total max power consumption for both motor lines must not exceed 10A or 20A depending on panel type.

Besides actuators, also locking actuators (espagnolettes actuators) type WMB 801/802 and WMB 811/812 can be connected. The power consumption of the locking actuators are not to be included in the 10A / 20A as actuators and locking actuators do not run at the same time.

All actuators on the same motor line will run/be operated simultaneously.
All actuators on the same motor line must be of the same type.

Connection / cable diameter: flexible max 6 mm² / solid max 10 mm².
Cable length: see the chapter "Cable dimensioning".

If cable monitoring is wanted, an "end of line motor module" type WSA 510 must be added in the last junction box. When using non-WindowMaster actuators the WSA 510 is added and the cable monitoring is set to "simple", see section "Cable monitoring of Actuators".

Motor lines X1 and X2 can be synchronized, so they run as a single motor line e.g. if more than 4 motors are installed on one window. Synchronization of motor lines requires FW 2.15.

Standard $\pm 24V$ actuators

Examples with 20A power consumption

- a) 20 pcs. WMX 826-1
- b) 10 sets of 2 pcs. WMX 826-2
- c) 4 pcs. WMU 885-1
- d) 2 sets of 2 pcs. WMU 885-2

Connection of standard actuators on motor line X1 (with cable monitoring)

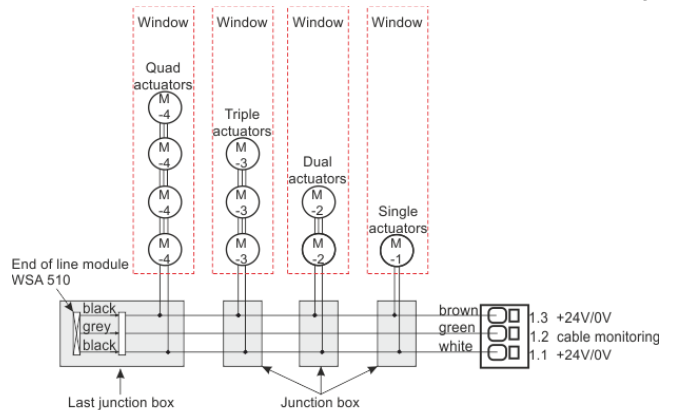

MotorLink[®] actuators

Examples with actuators per motor line

- Ex. 1: 4 pcs. WMX 823-1
- Ex. 2: 2 pcs. WMX 885-2
- Ex. 3: 3 pcs. WMU 826-3

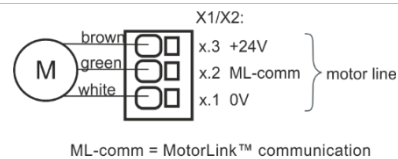

Allowed actuator combinations on a MotorLink[®] motor line

The two motor lines on the SP card can each be connected to one of the below shown combinations.

-1 (single): one window with one single window actuator. Up to four windows each with one single window actuator can be connected.

-2 (double): one window with two double window actuators.

-3 (triple): one window with three triple window actuators.

-4 (quad): one window with four quad window actuators.

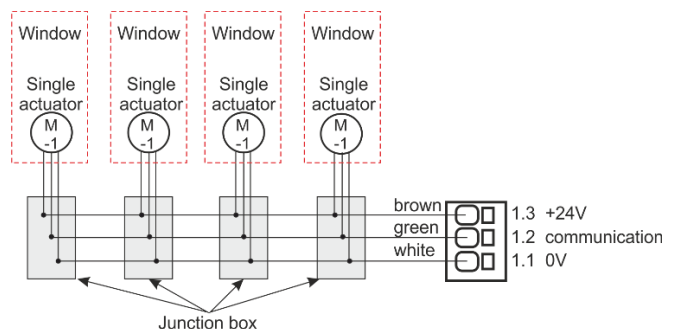

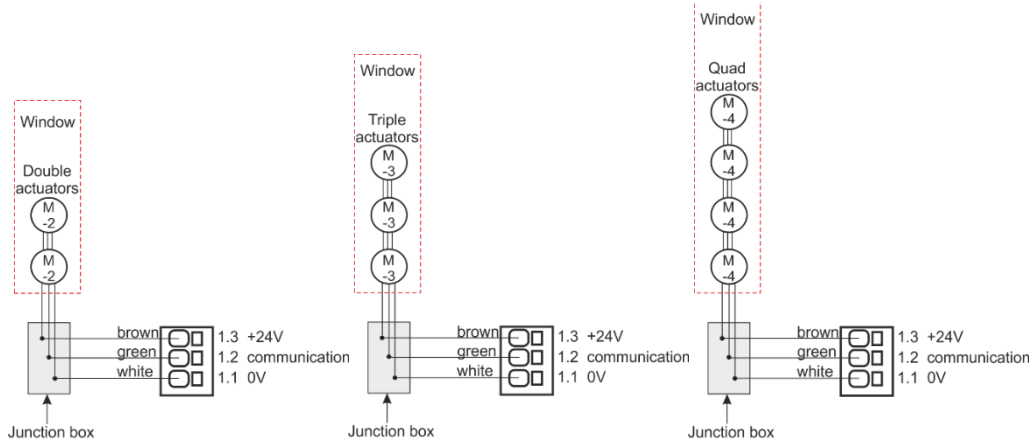

X3 / X4 For connection of comfort keypads. S1.X3 and S1.X4 are potential free / dry contacts.

Data

- | | |
|--------------|--------------|
| 3.1 Open | 4.1 Open |
| 3.2 Close | 4.2 Close |
| 3.3 GND / 0V | 4.3 GND / 0V |

With the default values are input:

- "Active" if the contact resistance is smaller than 2kΩ
- "Inactive" if the contact resistance is bigger than 3kΩ.

Input has pull up current of approx. 0.8mA. (min 0.7mA, max 1mA)

Example: comfort keypad connected to input X3

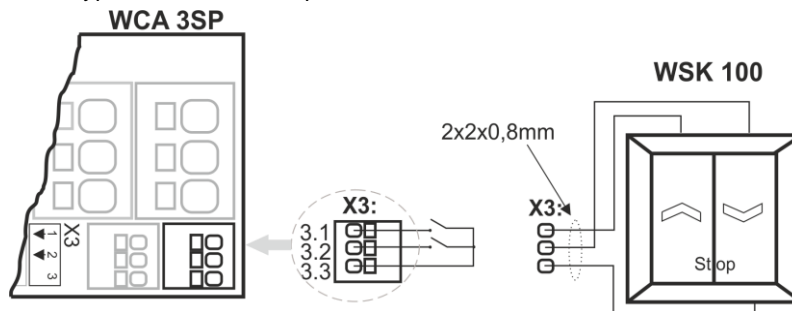

Input circuit (simplified)

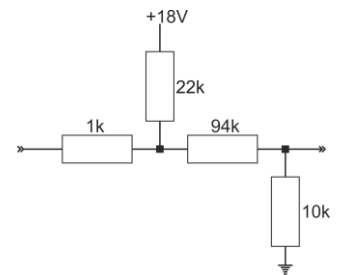

X3 / X4 can also be used as configurable inputs

Input 1

- 3.1 input 1.1
- 3.2 input 1.2
- 3.3 GND 1 / 0V

Input 2

- 4.1 input 2.1
- 4.2 input 2.2
- 4.3 GND 2 / 0V

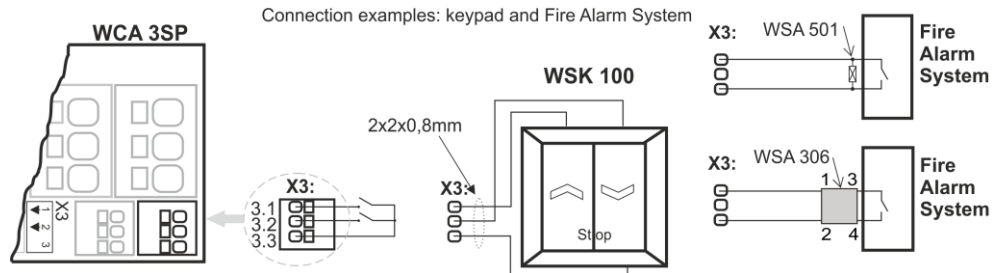

Fire Alarm System shown with cable monitoring type 1 and type 2:

Cable monitoring Type "1"

Type "1" is used with WSA 501.
This kind of cable monitoring detects only interruption.

Cable monitoring type "2"

Type "2" must be used in conjunction with WSA 306.
This type of cable monitoring is the most secure because it detects both interruption and short circuit.

X5 / X6

For connection of WSK-Link™ units (break glass unit type WSK 50x, indoor comfort room sensor type WWS 100 or Fireman's override switch WSK 510).

Data

Break glass unit bus 1	Break glass unit bus 2
5.1 24V	6.1 24V
5.2 Communication	6.2 Communication
5.3 0V	6.3 0V

As the break glass units are monitored, the connection of the break glass units depends therefore of the number of smoke zones.

- 1 smoke zone: connect to break glass unit bus 1. It is optional if they are connected in a ring.
- 2 smoke zones: connect to break glass unit bus 1 respectively to break glass unit bus 2. It is optional if they are connected in a ring.
- 3 or more smoke zones: break glass units are always to be connected in a ring.

Break glass units connected in a ring bus are not as sensitive to errors on the cables, as units which are not connected in a ring bus.

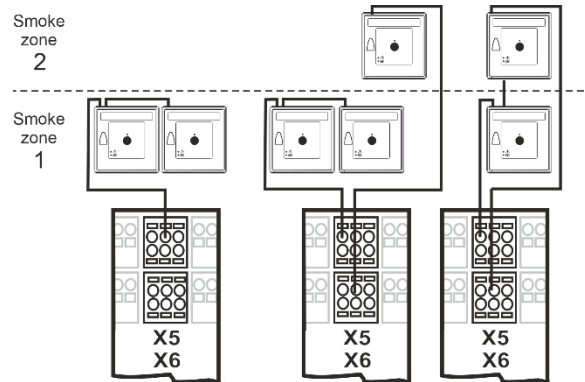

Smoke detectors and keypads can also be connected on the break glass unit type WSK 501 / 502.

Per panel up to 10 break glass units can be connected. But only 2 of these 10 (one per line) can be a type WSK 501 / 502 to which keypads or smoke detectors can be connected. The remaining break glass units must be type WSK 503 / 504.

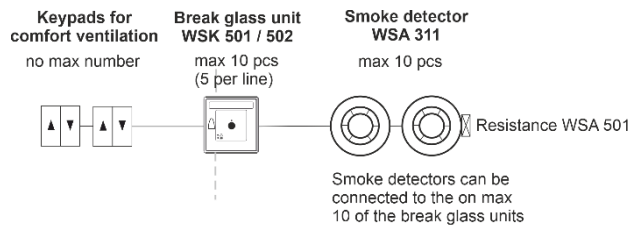

Max number of units allowed when WWS 100 room sensors are connected:

WSC 310 P: 2 x WWS 100 + 10 x WSK 50x

WSC 320 P: 10 x WWS 100 + 10 x WSK 50x

Only 2 of the 10 break glass units (one per line) can be a type WSK 501 / 502 to which keypads or smoke detectors can be connected. The remaining break glass units must be type WSK 503 / 504.

Refer to the instruction manual for WWS 100 for details.

Example of 2 smoke zones and 2 comfort zones

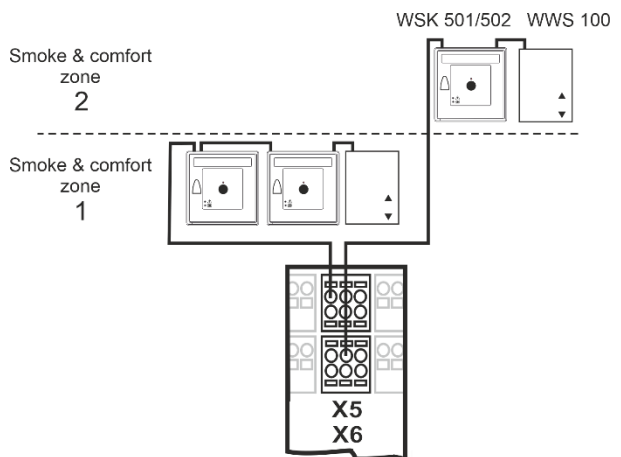

When WWS 100 is connected to WSK 501/502 it must be placed as the last component.

Example:

2 smoke zones and connected components; 2 break glass units type WSK 501 / 502 and 1 break glass unit type WSK 503 / 504, 3 smoke detectors WSA 311, 2 resistances WSA 501 and 3 comfort keypads.

Example

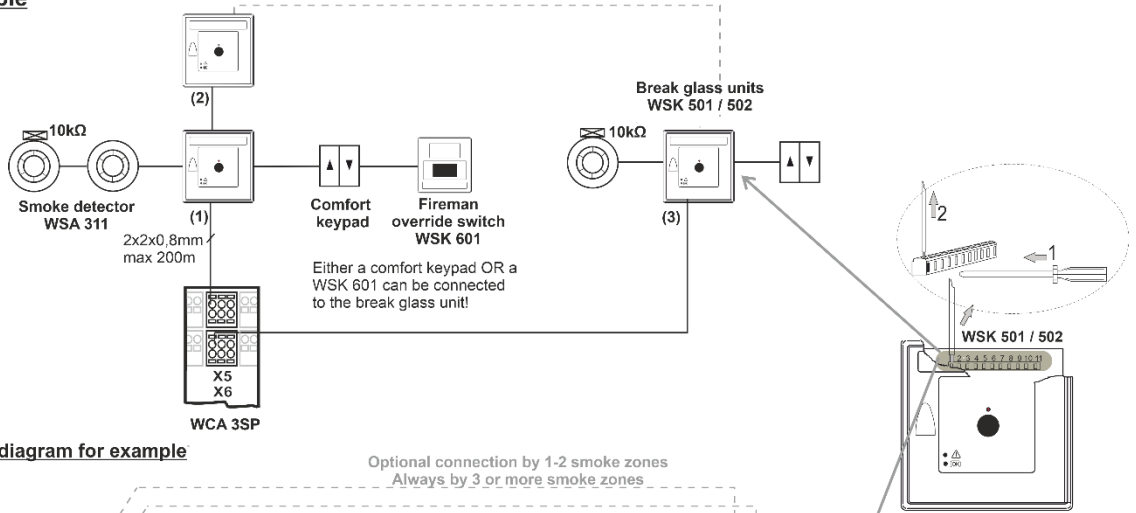

Wiring diagram for example

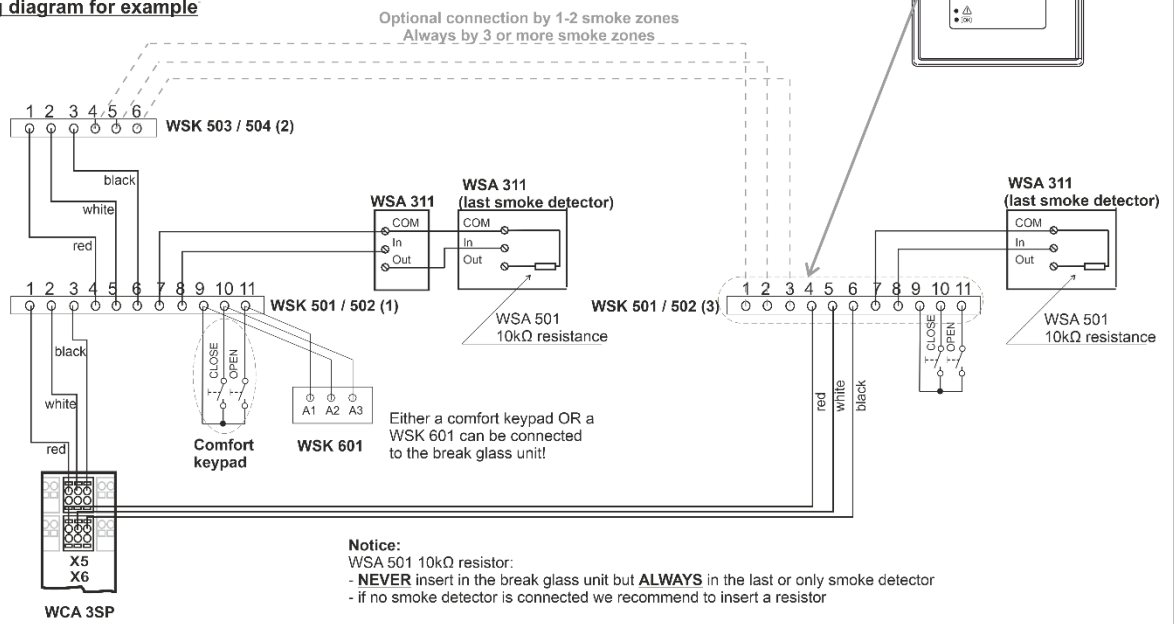

See chapter 9 "Cable plan for connection to WSC 3xx" for cable types and lengths.

Connection to Fireman's override switch type WSK 510

The WSK 510 can be connected directly to the smoke panel or to a break glass unit type WSK 50x. The WSK 50x and the WSK 510 can be connected in an arbitrary order. WSK 510 can only be connected to smoke panels type E2 and E4.

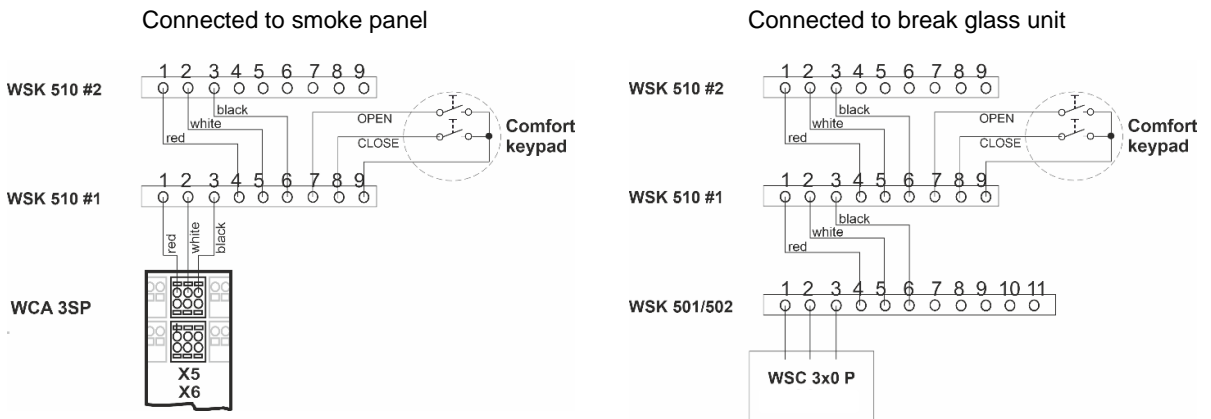

Comfort keypads can be connected to WSK 510. Smoke detectors cannot be connected to WSK 510. Please see WSK 510 instruction for configuration.

Connection of different types of smoke detectors to CompactSmoke™

	Smoke detector type			
	WSA 300	WSA 311	Hekatron MSD 523 (max 5 pcs)	Hekatron SSD 521/a (WSA 200 6101)
Connect to WCA 3SP	X7,1	L1 In	In +	2
	X7,2	L2	Com -	1
Connect to WSK	p 7	L2	Com -	1
	p 8	L1 In	In +	2
ALWAYS connect 10 KOhm in between	L2 and L1 Out	Com - and Out +	1 and 3	1 and 3

X7 For connection of smoke detector type WSA 311 and WSA 300.

Data

7.1 +

7.2 -

$I_{max} = 3,4mA$

Connection to WSA 311

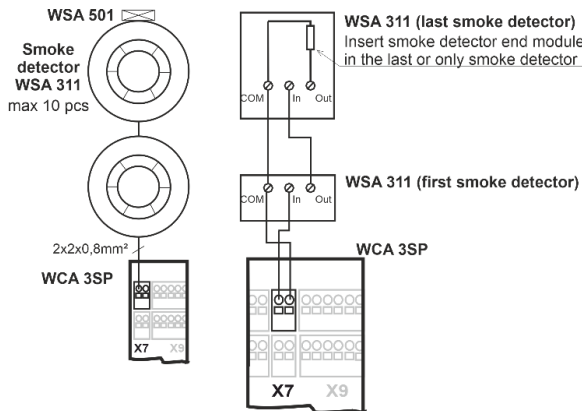

Connection to WSA 300

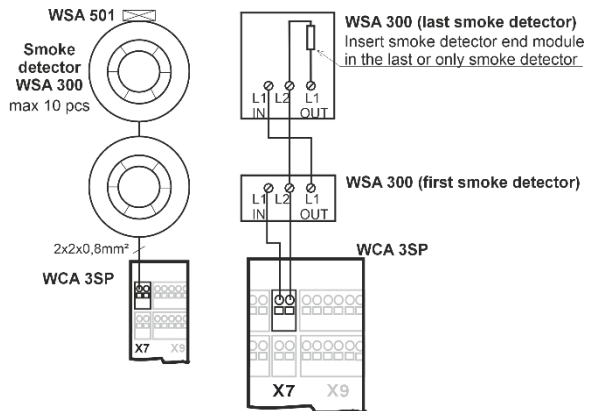

For connection of a different type smoke detector, see above.

When no smoke detector is connected to X7, a 10kΩ resistor is connected to the input.

X8 24/48V free configurable input from e.g. Fire Alarm System (used primarily in France).

Data

8.1 +

8.2 -

Active at voltages between 18 and 50V

Passive below 1V

Max.50V

Connection example

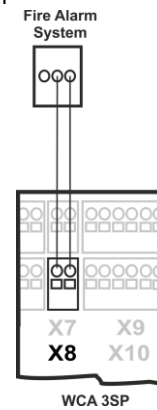

X9

Solid state outputs, one solid state output for transmission of fault signal to Fire Alarm System and 2 free configurable

Data

- 9.1 Fault – Open contact = Fault, closed contact = OK
- 9.2 Fault – Open contact = Fault, closed contact = OK
- 9.3 Output A
- 9.4 Output A
- 9.5 Output B
- 9.6 Output B

Solid state output for transmission of fault signal to Fire Alarm System.
A fault must last a minimum of 20 seconds before the relay indicate a fault.

Data

- Max voltage: 30 Vp (peak)
- Max output: 150 mA
- Typical On-resistance: 4,7 Ω
- Max On-resistance: 8 Ω
- Max switching speed: 2 ms

2 free configurable solid state outputs

- 9.3 Output A
- 9.4 Output A
- 9.5 Output B
- 9.6 Output B

Data

- Max voltage: 30 Vp (peak) AC/DC
- Max current: 150 mA
- Typical On-resistance: 4,7 Ω
- Max On-resistance: 8 Ω
- Max switching speed: 2 ms, only for DC-voltage

Output circuit (simplified)

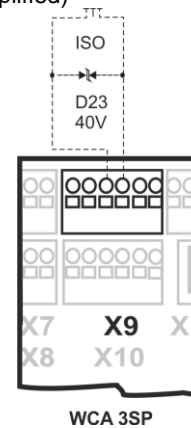

Example with solid state and relay (polarization is not important)

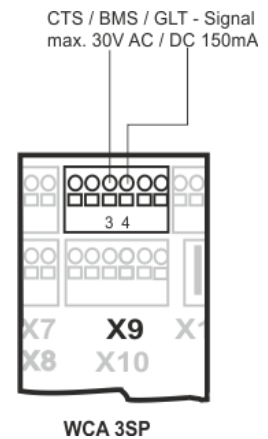
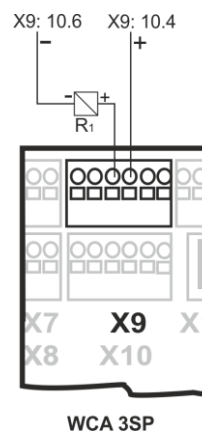

X10

For connection of weather station with wind direction.

Connection of wind / rain sensors type WLA 330 or WLA 340, rain sensor WLA 331.

Or connection of intelligent weather station (wind direction dependent smoke and heat extraction), e.g. WOW 600 (only with panel version 4 and 6).

Data

- 10.1 24V UPS
- 10.2 Wind speed
- 10.3 GND / 0V
- 10.4 24V
- 10.5 Rain (potential free / dry contact)
- 10.6 GND / 0V

With the default values are input:

"Active" if the contact resistance is smaller than 4kΩ

"Inactive" if the contact resistance is bigger than 8kΩ.

For values between 4 and 8kΩ the result will depend on the supply voltage.

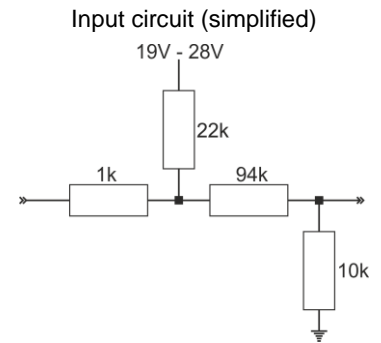

Input has pull up current approx. 1mA. (min 0.7mA, max 1.4mA)

Example 1: Wind/rain and rain sensors

WLA 330 and WLA 331 – the settings of the sensors are set on the sensor.

WLA 340 – the settings of the sensor are programmable on the smoke panels touch screen.

Data

- 10.1 24V UPS
- 10.2 Wind speed
- 10.3 GND / 0V
- 10.4 24V
- 10.5 Rain
- 10.6 GND / 0V

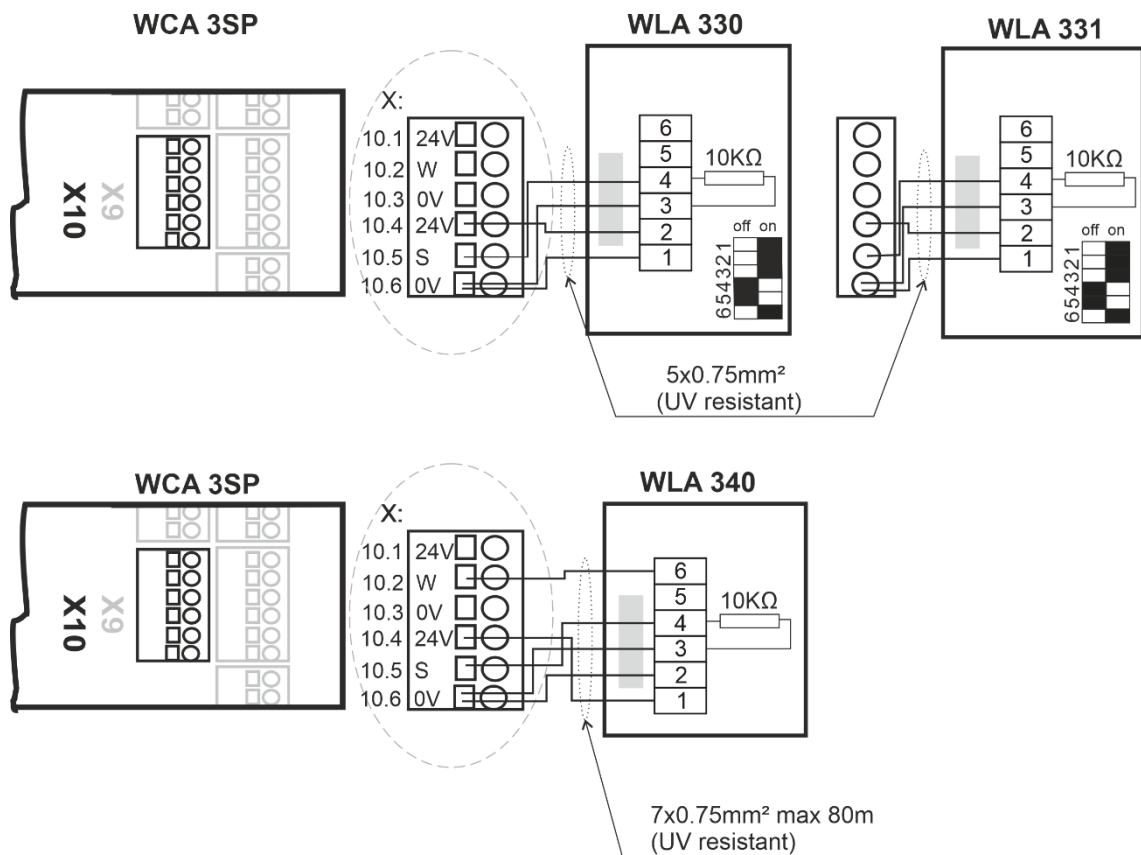

Example 2: Wind direction dependent ventilation (intelligent weather station)

Data

- 10.1 24V UPS
- 10.2 Wind speed / Direction
- 10.3 GND / 0V
- 10.4 24V
- 10.5 Rain
- 10.6 GND / 0V

As the weather station is monitored by both communication and time out (wind without time), any cable errors will be registered. A WOW 600 can only be connected to a panel version 4 and 6.

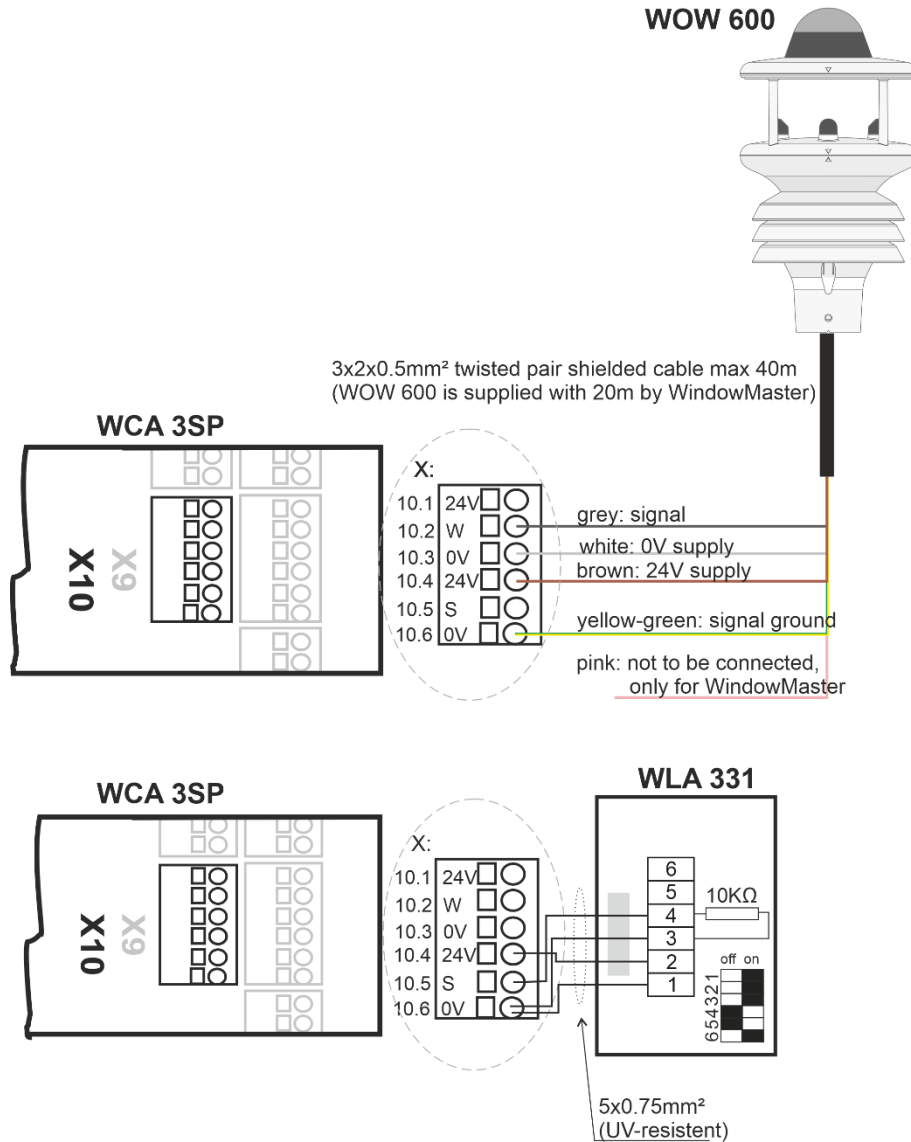

WOW 600 comes with 20m cable. The cable can be increased to 40m. The supplied cable can be used up to the vapor barrier. After the vapor barrier, there may be requirements for fireproof cables, so you must ensure that the installation complies with current national guidelines.

X11

For connection of master / slave connection via WSK-Link™.

Data:

11.1 24V IN

11.2 Communication IN

11.3 0V IN

On the master panel, either input X5 or X6 – the inputs also used for break glass units - are used for the connection. On the slave panel, the connection is done via X11.

It is possible to connect several panels in a master slave connection. However, the max total number of panels AND break glass units on the bus must not exceed 10 units. The max cable length between two units must not exceed 200m, see examples below, for how to connect the panels.

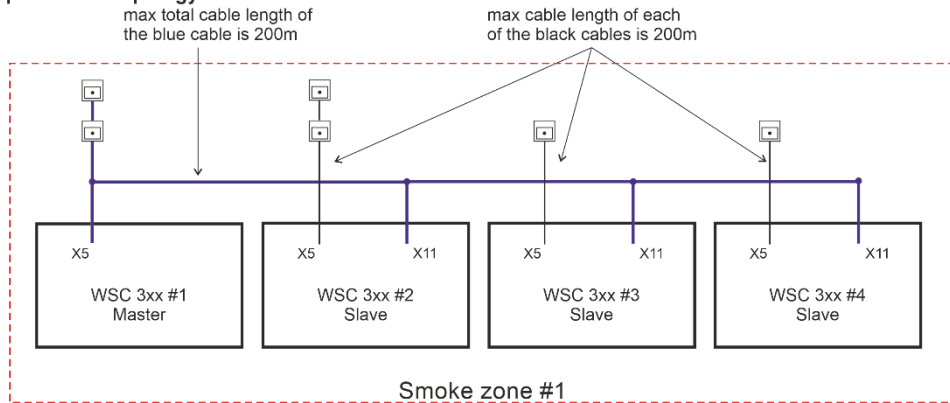
Example 1 - Bus topology

Max 10 units in total (smoke panels + break glass units)

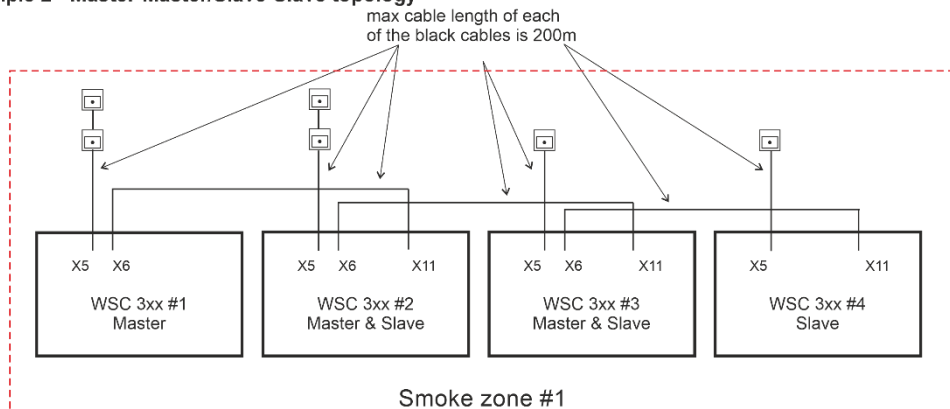
Example 2 - Master-Master/Slave-Slave topology

Max 10 units in total (smoke panels + break glass units)
Smoke panel #2 and #3 are both master and slave panels.

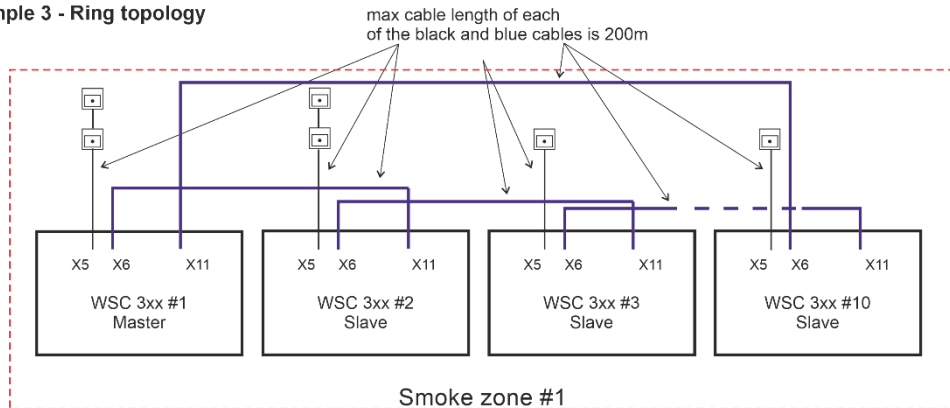
Example 3 - Ring topology

Max 10 units in total (smoke panels + break glass units)
See master-slave configuration for ring connection

With ring topology, max 10 units (smoke panels + break glass units) can be connected in a ring. We recommend connecting the alarm signal from the fire alarm system and/or the break glass unit to the master panel.

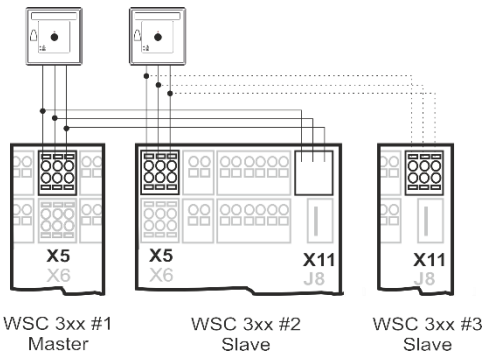

Both slave and break glass units are connected to the master on input X5 like above example 1 – limiting the available cable length.

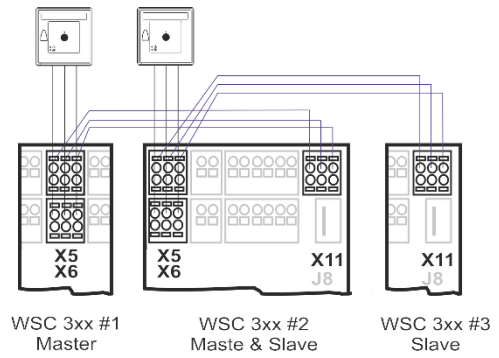

Slaves and break glass units are connected on both input X5 and X6 like above example 2 and 3. E.g., slave panels are connected to input X5 and break glass units are connected to input X6 – increasing the available cable length.

Even though the connecting method of panels shown in example 2 enables a physical larger system, with longer distances between panels and break glass units, WindowMaster recommends connecting the master slave panels as shown in example 1. As only the master panel sends smoke commands and slave panels only responds to commands received from the master panel, the response time in example 2 is heavily increased in comparison with the response time in example 1. Example 3 should be used where it is required that the system is robust and can withstand a single cable failure.

J1	Connection for power supply
J2	Power to motor line card
J3	Connection for battery (power back-up)
J4	Connection for motor line card (WCA 3M8)
J7	2 x Ethernet connection
J8	USB host. Used to store configurations and to start an event log for e.g., trouble shooting
J9	USB device. Used for remote control and to flash the panel.
J10	Connection for fieldbus card
P1	Power supply control
R / P	Reset / programming (used for firmware updates)
LED	<p><u>Shows the status of the panel</u></p> <p>Red = alarm</p> <p>Yellow = fault, flashing yellow = service timer expired, time for service</p> <p>Green fast flickering = all OK (CPU working), Green constant = CPU communication stopped (possible reset or contact WindowMaster)</p>
↓ ↑	Close / open all windows
BH1	<p>vBAT, back-up battery for CPU and system clock</p> <p>The vBAT battery is a 3V lithium coin cell battery, which keeps the CPU and system clock running in case of total power failure (both mains and mains backup battery failure).</p> <p>If vBAT voltage drops below 1.65 V an vBAT error can be seen in the power supply menu and the battery must be replaced.</p> <p>vBAT type: 1 pcs. Lithium CR 1220 3V</p>

11.5 Motor line card – WCA 3M8

The motor line card WCA 3M8, allows connection of additional 8 motor lines either $\pm 24V$ standard or MotorLink®.

The WCA 3M8 is connected to WCA 3SP via a CAN-cable (J3 on the WCA 3M8 and J4 on the WCA 3SP).

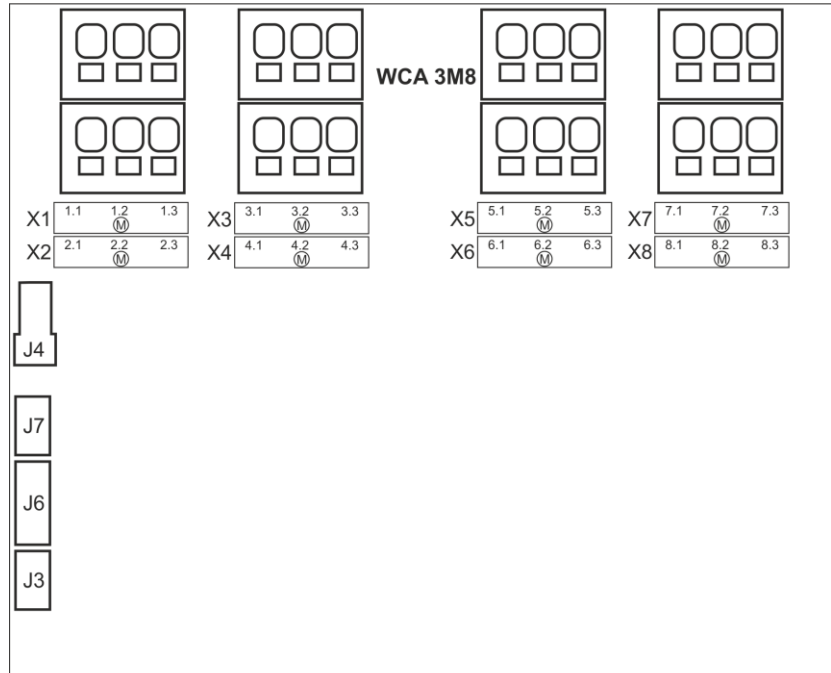

X1	1.1 24V / 0V 1.2 Cable monitoring / MotorLink } Motorline 1.3 0V / 24V	X7	7.1 24V / 0V 7.2 Cable monitoring / MotorLink } Motorline 7.3 0V / 24V
X2	2.1 24V / 0V 2.2 Cable monitoring / MotorLink } Motorline 2.3 0V / 24V	X8	8.1 24V / 0V 8.2 Cable monitoring / MotorLink } Motorline 8.3 0V / 24V
X3	3.1 24V / 0V 3.2 Cable monitoring / MotorLink } Motorline 3.3 0V / 24V	J3	Connection for main control module
X4	4.1 24V / 0V 4.2 Cable monitoring / MotorLink } Motorline 4.3 0V / 24V	J4	Power connection from main control module (WCA 3SP)
X5	5.1 24V / 0V 5.2 Cable monitoring / MotorLink } Motorline 5.3 0V / 24V	J6	Connection to input expansion module (WCA 3KI)
X6	6.1 24V / 0V 6.2 Cable monitoring / MotorLink } Motorline 6.3 0V / 24V	J7	Power supply control

X1 – X8	For connection of $\pm 24V$ Standard actuators or MotorLink® actuators. <u>Data:</u> x.1 24V / 0V x.2 Cable monitoring / Communication x.3 0V / 24V For actuator connections, please see explanation in section “WCA 3SP main control card” under “X1 / X2” and “Max number of actuators per card”.
J3	Connection to main control card (WCA 3SP)
J4	Power connection from control card (WCA 3SP)
J6	Connection to input card (WCA 3KI)
J7	Power supply control

11.6 Keypad card – WCA 3KI

The keypad card allows connection of 10 keypads. WCA 3KI requires the WCA 3M8 actuator card.

The WCA 3KI is connected to WCA 3M8 via cable (J1 on the WCA 3KI and J6 on the WCA 3M8).

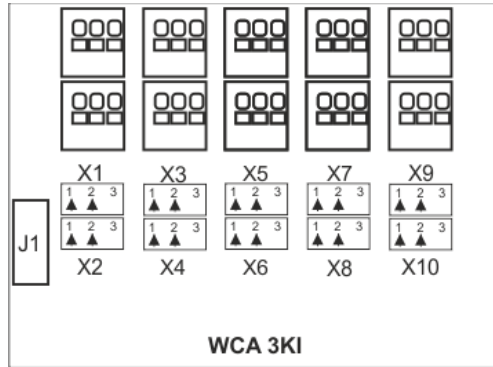

X1	1.1 Open 1.1 1.2 Close 1.2 1.3 GND / 0V	} Comfort keypad #1	X7	7.1 Open 7.1 7.2 Close 7.2 7.3 GND / 0V	} Comfort keypad #7
X2	2.1 Open 2.1 2.2 Close 2.2 2.3 GND / 0V	} Comfort keypad #2	X8	8.1 Open 8.1 8.2 Close 8.2 8.3 GND / 0V	} Comfort keypad #8
X3	3.1 Open 3.1 3.2 Close 3.2 3.3 GND / 0V	} Comfort keypad #3	X9	9.1 Open 9.1 9.2 Close 9.2 9.3 GND / 0V	} Comfort keypad #9
X4	4.1 Open 4.1 4.2 Close 4.2 4.3 GND / 0V	} Comfort keypad #4	X10	10.1 Open 10.1 10.2 Close 10.2 10.3 GND / 0V	} Comfort keypad #10
X5	5.1 Open 5.1 5.2 Close 5.2 5.3 GND / 0V	} Comfort keypad #5			
X6	6.1 Open 6.1 6.2 Close 6.2 6.3 GND / 0V	} Comfort keypad #6	J1	Connection to actuator card (WCA 3M8)	

X1 – X10 S3.X1 – S3.X10 are potential free / dry contracts.

Data:

x.1 Open x.1
x.2 Close x.2
x.3 GND / 0V

For input connections, please see explanation in section “WCA 3SP main control card” under “X3 / X4”.

J1 Connection to motor line card (WCA 3M8)

11.7 Fieldbus cards

Different versions of fieldbus cards are available

- WCA 3FK Fieldbus card with KNX interface
- WCA 3FM Fieldbus card with BACnet MSTP interface
- WCA 3FB Fieldbus card with BACnet IP interface

The connection of a fieldbus card enables communication and access to the available bus-objects depending on the chosen system. Smoke extraction function has always higher priority than comfort commands from the fieldbus and it is recommended only to use fieldbus for comfort purposes. There is a set of KNX and BACnet objects available for each motor line, motor group and smoke zone, which provides the options for status and commands.

Status options

E.g., actual position, fault and operation status and the max opening angle (degrees).

Command options

E.g., target position commands with different priority and MotorLink® actuator speed.

See "WCA 3FK Application Programming Description.pdf" and BACnet PICS for further information on available KNX and BACnet communication objects.

12 Cable monitoring of actuators

Actuators with MotorLink® are monitored by data communication.

When using ±24V standard actuators either diodes or 10kΩ resistors can be used for cable monitoring, see below.

Configuration of cable monitoring with ±24V actuators					
<div style="border: 1px solid black; padding: 5px;"> <div style="display: flex; align-items: center; margin-bottom: 5px;"> <input checked="" type="checkbox"/> View all details, Motor line, X1: Wire cable check type </div> <table border="1" style="width: 100%; border-collapse: collapse;"> <tr> <td style="padding: 2px;">Diodes (WSA 432)</td> <td style="padding: 2px;">10k0hm resistors (WSA 510)</td> </tr> <tr> <td style="padding: 2px;">10k0hm resistors, simple (WSA 510)</td> <td style="padding: 2px; text-align: center;">✓</td> </tr> </table> <div style="display: flex; justify-content: space-around; margin-top: 10px;"> <div style="border: 1px solid black; padding: 2px; width: 30px; text-align: center;">✗</div> <div style="border: 1px solid black; padding: 2px; width: 30px; text-align: center;">✓</div> </div> </div> <p style="text-align: center; margin-top: 5px;">Configuration of cable monitoring</p>	Diodes (WSA 432)	10k0hm resistors (WSA 510)	10k0hm resistors, simple (WSA 510)	✓	<p>10kΩ-resistors (WSA 510) – monitors ever single core for interruption. Works with all WindowMaster actuators (default setting).</p> <p>Diodes (WSA 432) – monitors every single core for interruption. Works with all WindowMaster actuators.</p> <p>10kΩ- resistors, simple (WSA 510) – monitors for interruption on the entire cable. Works with all WindowMaster actuators and most non-WindowMaster actuators.</p>
Diodes (WSA 432)	10k0hm resistors (WSA 510)				
10k0hm resistors, simple (WSA 510)	✓				

12.1 Usage of non-WindowMaster actuators

When using non-WindowMaster actuators the cable monitoring is set to "simple".

Configuration of cable monitoring with non-WindowMaster actuators					
<div style="border: 1px solid black; padding: 5px;"> <div style="display: flex; align-items: center; margin-bottom: 5px;"> <input checked="" type="checkbox"/> Configuration, Motor line, X1: Wire cable check type </div> <table border="1" style="width: 100%; border-collapse: collapse;"> <tr> <td style="padding: 2px;">Diodes (WSA 432)</td> <td style="padding: 2px;">10k0hm resistors (WSA 510)</td> </tr> <tr> <td style="padding: 2px;">10k0hm resistors, simple (WSA 510)</td> <td style="padding: 2px; text-align: center;">✓</td> </tr> </table> <div style="display: flex; justify-content: space-around; margin-top: 10px;"> <div style="border: 1px solid black; padding: 2px; width: 30px; text-align: center;">✗</div> <div style="border: 1px solid black; padding: 2px; width: 30px; text-align: center;">✓</div> </div> </div> <p style="text-align: center; margin-top: 5px;">Configuration of cable monitoring</p>	Diodes (WSA 432)	10k0hm resistors (WSA 510)	10k0hm resistors, simple (WSA 510)	✓	<p>If cable monitoring of non-WindowMaster® actuators connected to the CompactSmoke™ is required the cable monitoring type is set to "simple".</p>
Diodes (WSA 432)	10k0hm resistors (WSA 510)				
10k0hm resistors, simple (WSA 510)	✓				

13 Back-up batteries

Connect 2 pcs. back-up batteries type WSC 007 for WSC 310 and type WSA 012 for WSC 320.

See section 23 "Maintenance" for further information.

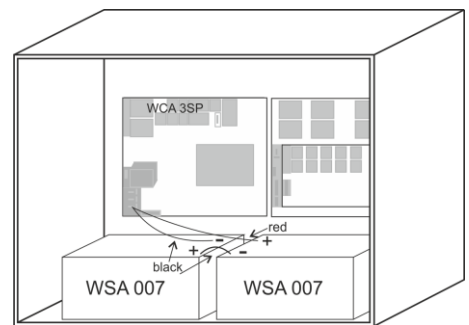

Example of WSC 310 panel with back-up batteries.



It is possible to deselect the emergency power batteries if the panel can be supplied from a 230V emergency power system such as a UPS or a 230V No-break system.

The emergency power system must fulfil the requirement for secondary supply in EN 12101-10 section 6.2. Specifically, the emergency power system must be able to keep the panel in operation for at least 72 hours, after which it must be able to supply 20A for 180 seconds.

IMPORTANT - If 230V emergency power is used, there must NOT be any interruption of supply when switching from 230V supply to emergency power supply.

Deselecting emergency power batteries is configured under the menu item "See all details" "System".

13.1 Measurement of battery charging voltage

 View all details, Power supply Mains status OK Battery status OK Back-up batteries voltage 27.4 V Power supply voltage 27.6 V  	<ol style="list-style-type: none"> 1. Select "Power supply" under „View all details" 2. Read the "Back-up batteries voltage" 3. Connect a voltmeter to the batteries and read the the batter voltage 4. Compare the two values, if no error is indicated on the panel (green icon) AND the difference between the two values is less than 250mV, then the charger is okay.
--	--

14 Touch screen











The plus version of the smoke ventilation panel comes with a touch screen. All connected components (actuators, break glass units, keypads, weather station etc.) are to be configured on the touch screen.

The menu of the touch screen is in steps:

Step 1: main menu

Step 2: sub menu

Step 3: configuration / showing / operation of the sub menu

 Hardware OK No fire conditions Configuration Status Manual operation  	 Configuration Motor line ? Motor group WSK-Link™ Smoke zone  												
Step 1: Main menu  Configuration, Motor line, X1 Output mode ±24V motor Motor configuration None 	Step 2: Sub menu  Status, Motor group <table border="1"> <tr><td>1</td><td>2</td><td>3</td><td>4</td><td>5</td><td>6</td></tr> <tr><td>7</td><td>8</td><td>9</td><td>10</td><td></td><td></td></tr> </table> 	1	2	3	4	5	6	7	8	9	10		
1	2	3	4	5	6								
7	8	9	10										
Step 3: Configuring the sub menu  4.106 Output mode Specify the mode of the motor output.	Step 4: Showing the sub menu Help text The touch screen has a help function with text explaining the menu item. The help text occurs when the menu item is pressed (text on white background). For displaying the help text: → press the item e.g., "Motor type" → the help text appears → to turn off the help text press the screen.												

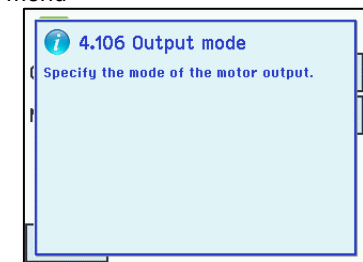



Help text

14.1 Icons

The smoke ventilation panel has icons for quick viewing of: fire conditions, hardware OK and hardware error:

 **Fire conditions:** smoke alarm has been triggered.

 **Hardware OK:** actuators and break glass units have been configured correctly.

 **Hardware error:** hardware error or connected actuators and break glass units has not been configured correctly in motor lines, motor groups or smoke zones.

14.2 Rotation of the touch screen

The picture on the touch screen can be rotated 180°

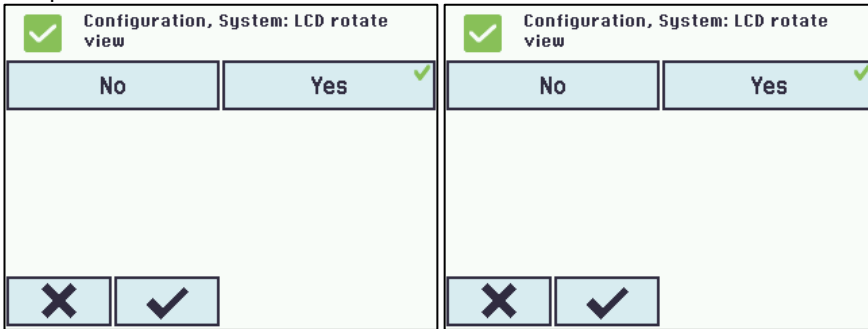

15 Configuration – main menu

All connected components (actuators, break glass units, keypads, weather station etc.) are to be configured.

As the panel has pre-settings for PIN code for access to level 3, the code is to be entered before it is possible to begin the configuration (see chapter 14.13 “Log in”).

Before starting on the configuration it can be an advantage to change some of the pre-set settings. Ex. the language can be changed from English to Danish or German (see section 15.16 “System”) and the orientation of the text on the touch screen can be rotated for a better viewing angle (see section 13.2 “Rotation of the touch screen”). It is also possible to change the log out time, which is the time that the access to the access level is open/the touch screen in on (see section 14.13 “Log in”)

To configure a sub menu:

→ press the light blue number field

→ enter value / the number of the motor line / change factory settings etc. The setting which can be entered depends of the type of the sub menu.

→ accept on

A menu can consist of more screen plays. To get to the next screen: → press

15.1 Motor lines – motor groups – smoke zones

All the components are to be assigned to groups and zones:

- motor lines are to be assigned to motor groups
- motor groups can be assigned to smoke zones
- break glass units and smoke detectors are to be assigned to smoke zones
- keypads are to be assigned to one or more motor groups

15.1.1 Examples with motor lines / motor groups / smoke zones

- 6 motor lines: one or more actuators connected to the lines
- 3 motor groups: the actuators in the motor group are operated simultaneously on the keypad
- 2 smoke zones: the actuators in the smoke zone are operated simultaneously on the break glass unit

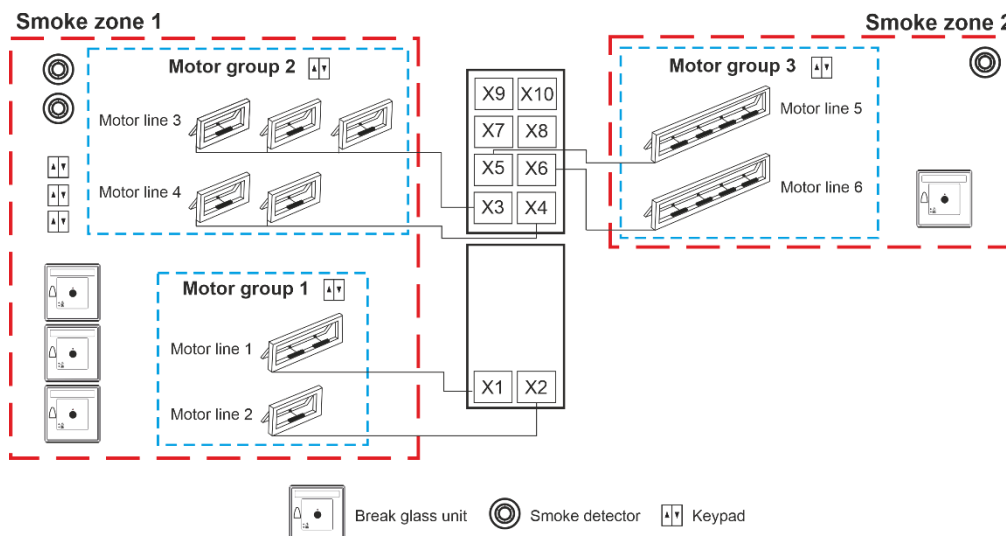

15.2 Motor line

Actuators are to be connected on the motor lines.

±24V standard actuators and actuators with MotorLink® can be connected to all motor lines, but a motor line can only be connected to one type of actuators – either ±24V standard or MotorLink® actuators.

15.2.1 Motor line - numbering

All motor lines are numbered and they are all to be configured.

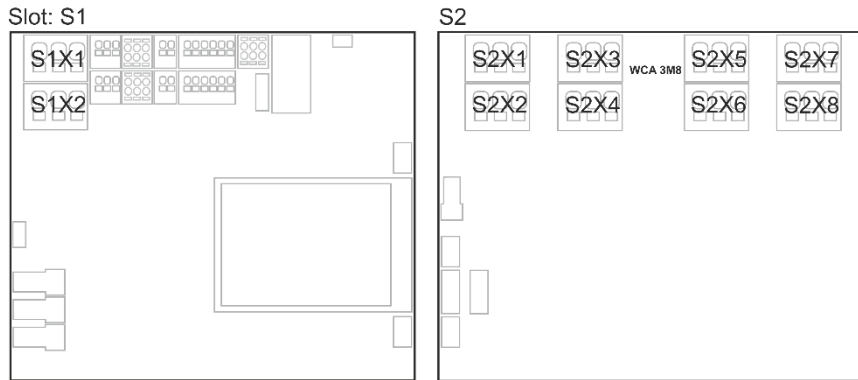

15.2.2 Motor line - configuration

Press "Motor line" and the overview of the motor lines in the smoke ventilation panel is shown.

Overview configuration motor lines

Configuration, Motor line

All
X1
X2

One motor line is marked with a as the configuration is missing.

Configuration, Motor line

All
X1
X2

All motor lines are configured.

Both actuators outputs on the main control card as well as the eight actuators outputs on the motor line card – if such is connected – are to be configured:

- Motor lines with actuators connected are to be configured in "motor group"
- Motor lines with no actuator connected are set to "none"

Since ±24V actuators and actuators with MotorLink® are not to be configured exactly the same way, both type of actuators are listed below with the settings that are to be configured for each actuator type. Be aware that both types of actuators can be connected to the smoke panel at the same time.

For ±24V actuators the full chain length is defined as a runtime of 60 seconds. When the smoke panel is to be 100% sure that the windows are 100% open or closed, the chain length is run twice (120). This can have an influence when configuring a sequence control.

Motor lines configuration

Configuration, Motor line, X1

Output mode:

Motor configuration:

Stroke time:

Motor group:

±24V actuator configuration

The ±24V actuators are to be configured in:

1. Output mode: informs the type of the actuator selected
2. Motor configuration
3. Stroke time
4. Motor group
5. Manual command - auto off-period
6. Retry during alarm
7. Sequential control type
8. Sequential control position limit
9. Sequential control with
10. Sequential control with no
11. Sequential control position logic
12. Sequential control position
13. Sequential control position

The appendix contains all the menus that can be configured - see appendix for detailed explanation.

The MotorLink® actuators are to be configured in:

Configuration, Motor line, X1

Output mode:

Expected no. of motors:

Motor group:

Expected no. of locking motors:

MotorLink® motor configuration

1. Output mode: informs the type of the actuator selected
2. Expected no. of motors (*displayed if actuator type = MotorLink®*)
3. Motor group
4. Expected no. of locking motors
 - 4.1 No. of found locking motors (*see appendix*)
5. Manual speed
6. Auto. speed
7. Manual command – auto off period
8. Retry during alarm
9. Max unexpected overcurrent
10. Max unexpected overcurrent (motor)
11. Sequential type
12. Sequential position limit
13. Sequential control with
14. Sequential control with no
15. Sequential control position logic
16. Sequential control position
17. Sequential control position

The appendix contains all the menus that can be configured - see appendix for detailed explanation.

Motor lines – maximum current configuration

View all details, Motor line, S1 X1

Maximum current:

Keep motor line powered:

High priority open:

High priority open is 1st comfort priority:

Whether ±24V or MotorLink™ actuators are used, the motor line can be configured to a maximum current of either 5, 10 or 20A.

The configuration is made in the “Motor Line” menu under “View all details”.

The total power consumption of all connected actuators must not exceed 10A or 20A depending on panel size.

Motor lines – synchronisation of ML1 and ML2 configuration

View all details, Motor line, S1 X1

Chain length:

Service position:

Position scale:

Synchronise with ML 2:

Synchronisation of ML1 & ML2

When motor line ML1 and ML2 are to be synchronised / run as a single motor line “Synchronise with ML2” must be set to “Yes”.

The configuration is made in the “Motor Line” menu under S1X1 in “View all details”.

Only the two motor lines on the main card can be synchronised - S1X1 and S1X2.

All motors connected to ML1 and ML2 must be of the same type and configuration and be MotorLink™ motors.

Synchronisation of motor lines requires FW 2.15.

15.2.3 Colour code - motor line

The overview fields on the touchscreen have colour codes for the motor lines:

Colour	Meaning
Yellow triangle icon 	The motor line are to be configured or there is a fault in the actuator
Strikethrough grey	No configuration of the motor line / the motor line doesn't exist
Black text	The motor line are configured, the actuator has not been closed
Green	The motor line has been configured; the actuator has been closed MotorLink® motor lines will be marked in green, if the actuator / actuators on the motor line has been closed 100% and the point zero of the actuator has been determined.
Light grey number	The motor line are configured with 'No actuator are connected'
Blue ?	Configuration is missing or there is a mistake in the configuration
Red	The motor line has been given alarm signal

15.3 Motor group

All motor groups are to be assigned to a smoke zone and multiple motor groups can be assigned to the same smoke zone. See the example "Example of motor lines / motor groups / smoke zones" in the beginning of this chapter for further details.

When configuration specify the number of the smoke zone that are to control the motor group.

15.3.1 Motor group - configuration

Press "Motor group" and the overview of the motor groups in the smoke ventilation panel is shown.

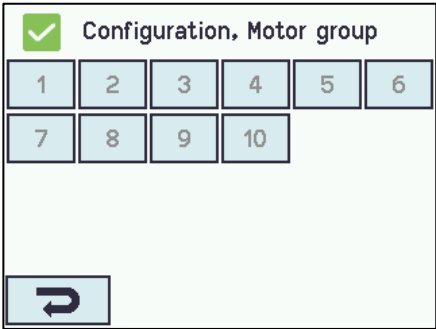
Motor group configuration	
 <p style="text-align: center;">Motor group overview</p>	<p>Motor groups are to be configured in:</p> <ol style="list-style-type: none"> 1. Controlling smoke zones 2. Comfort open position 3. Comfort open close time 4. Use 'safety' from smoke zone 5. Wind directions where to close during alarm <p>The appendix contains all the items that can be configured - see appendix for detailed explanation.</p>

15.3.2 Colour code – motor group

The overview fields on the touch screen have colour codes for the motor groups:

Colour	Meaning
Yellow triangle icon 	One or more of the assigned motor lines has a failure
Black text	The motor group is configured
Green field	All the assigned motor lines are closed
Light grey number	The motor group is configured but no motor lines are assigned
Blue ?	Configuration is missing or there is a mistake in the configuration
Red	The motor group has been given alarm signal

15.4 Break glass unit

A break glass unit shall be assigned to a smoke zone and multiple break glass units can be assigned to the same smoke zone. See the example "Example of motor lines / motor groups / smoke zones" in the beginning of this chapter for further details.

15.4.1 Break glass unit configuration

The break glass units are configured in the WSK-Link™ menu.

First the break glass units must be configured according to the topology (if they are connected one by one or in a ring) and then follow the individual configuration of the break glass units according to smoke zones, comfort motor groups etc.

To be sure it is the right glass break unit that is configured; it is possible to locate the break glass unit in one of two ways:

1. Press the reset button and a blue speech bubble will appear in the selected break glass unit in the overview of the break glass units / WSK-Link™ units.
2. Press the number of the selected break glass unit on the overview on the touch screen → press  until the menu point appears – “bip 1min for locating” is shown → press “No” → select “Yes”. The selected break glass unit will now beep if the door on the break glass unit is closed.



Topology

The break glass units are monitored and the connection of the break glass units to the smoke ventilation panel depends of the number of smoke zones:

1. when 1 smoke zone the break glass units are connected in series and connected directly to the WCA 3SP card
2. when 2 smoke zones the break glass units are connected in each their series and connected directly to the WCA 3SP card
3. when 3 smoke zones the break glass units are connected in a ring

See section “10.4 main control card WCA 3SP” for further information on connection of break glass units.

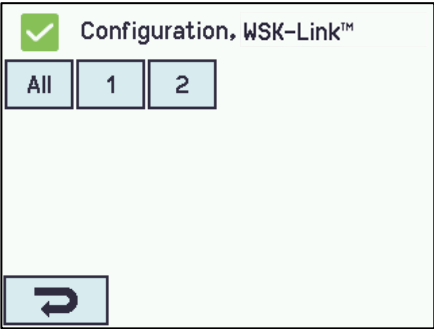
Note: The break glass unit must be set in ring and the setting to “Yes” to have the error indication on the ‘All’ (group field) on the overview of the WSK-Link™ units.

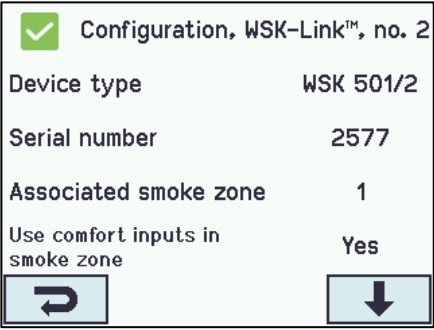
Break glass unit / WSK-Link™ - configuration	
 <p>Overview 'WSK-Link' units</p>	<p>Overview 'WSK-Link' units</p>
Break glass units are to be configured in:	
 <p>Configuration of 'Topology'</p>	<p>'All'</p> <ol style="list-style-type: none"> 1. Bus topology is ring - see text about “Topology” below <p>The appendix contains all the items that can be configured - see appendix for detailed explanation.</p>
 <p>Configuration of a selected 'WSK-Link™ unit' - shown for no.2</p>	<p>The numbered WSK-Link™ units</p> <ol style="list-style-type: none"> 1. Device type (<i>break glass unit or slave panel</i>) 2. Serial number: the break glass unit's unique serial no. is shown (cannot be configured) 3. Associated smoke zone 4. Use comfort inputs in smoke zone 5. Comfort motor group 6. Br.glass unit+sensor same smoke zone <ol style="list-style-type: none"> 6.1 Smoke sensor associated with smoke zone (<i>displayed only if 'Other smoke zone' is selected</i>) 7. Unit beep 1min for locating 8. Delete this unit <p>The appendix contains all the items that can be configured - see appendix for detailed explanation.</p>

15.4.2 Colour code – break glass / WSK-Link™ unit





The overview fields on the touch screen have colour codes for the break glass units:

Colour	Meaning
Yellow triangle icon 	Sensor error
Black text	The break glass unit are assigned to a smoke zone
Blue speech bubble	The reset-button in the break glass unit is pressed down (used when detecting break glass unit)
Light grey number	The break glass unit is not assigned to a smoke zone
Blue ?	Configuration is missing or there is a mistake in the configuration
Red	The alarm button in the break glass unit is pressed down (alarm signal)

15.5 Smoke zone

Here is to be configured master/slave and control zones.

Here can also be configured e.g., different opening limits of the windows when alarm is triggered.

Smoke zones configuration													
<div style="border: 1px solid black; padding: 5px;"> <p><input checked="" type="checkbox"/> Configuration, Smoke zone</p> <table border="1" style="width: 100%; text-align: center;"> <tr> <td>All</td> <td>1</td> <td>2</td> <td>3</td> <td>4</td> <td>5</td> </tr> <tr> <td>6</td> <td>7</td> <td>8</td> <td>9</td> <td>10</td> <td></td> </tr> </table> <p style="text-align: right;"></p> </div> <p style="text-align: center;">Overview 'Smoke zones'</p>	All	1	2	3	4	5	6	7	8	9	10		<p>Overview 'Smoke zones'</p>
All	1	2	3	4	5								
6	7	8	9	10									
The smoke zone are to be configured in:													
<div style="border: 1px solid black; padding: 5px;"> <p><input checked="" type="checkbox"/> Configuration, Smoke zone</p> <p>High temperature threshold 72.0 °C</p> <p>Target smoke zones <input style="width: 50px;" type="text" value="1"/></p> <p>Target smoke zone function <input style="width: 50px;" type="text" value="Line A"/></p> <p>Associated WSK bus master smoke zone <input style="width: 50px;" type="text" value="1"/></p> <p style="text-align: right;"></p> </div> <p style="text-align: center;">Configuration of 'All'</p>	<p>All</p> <ol style="list-style-type: none"> 1. High temp. target smoke zones 2. High temp. target smoke zone function 3. Slave target Smoke zone 4. <p>The appendix contains all the items that can be configured - see appendix for detailed explanation.</p>												
<div style="border: 1px solid black; padding: 5px;"> <p><input checked="" type="checkbox"/> Configuration, Smoke zone, no. 1</p> <p>Reset higher priority than break glass unit (Line A) <input style="width: 50px;" type="text" value="No"/></p> <p>Buzzer active during alarm <input style="width: 50px;" type="text" value="Yes"/></p> <p>Controlled smoke zone <input style="width: 50px;" type="text" value="-"/></p> <p>Error generates alarm <input style="width: 50px;" type="text" value="No"/></p> <p style="text-align: right;"> </p> </div> <p style="text-align: center;">Configuration of a specific 'Smoke zone'</p>	<p>The numbered smoke zones</p> <ol style="list-style-type: none"> 1. Reset higher priority than break glass unit (Line A) – see <i>explanation and table below</i> 2. Buzzer active during alarm 3. Controlled smoke zone <ol style="list-style-type: none"> 3.1 Target smoke zone function (<i>displayed only if one or more smoke zones is/are selected</i>) 4. Error generates alarm 5. Line B (smoke detector) smoke opening pos. 6. Use comfort commands 7. Wind direction speed threshold <p>The appendix contains all the items that can be configured - see appendix for detailed explanation.</p>												

Line

Some of the functions refer to 'Line'

The % value for the lines is configurable for each smoke zone. This is done in 'View all details'. Furthermore, in "View all details" – "Smoke zone" Line E and Line F can be given the highest priority, this is only used for fireman's override panels.

Line	%	Function	Used for
A	100%	open	break glass unit
B	100%	open	smoke detector (Switzerland: the value is often set to 0%, thus the windows will close when smoke)
C	100%	open	
D	0%	close	
E	100%	open	
F	0%	close	
Reset			if this is selected the chosen function(s) will be reset

Number of smoke detectors to give an alarm:

If it is selected, that the alarm is only triggered when more smoke detectors give alarm, the smoke detectors are to be connected to separate break glass unit – see drawing:

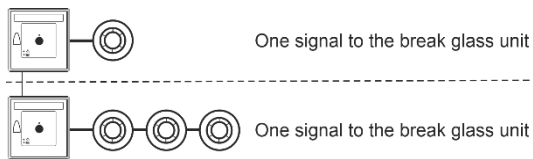

15.6 Local input

The smoke control unit has nine inputs on the main control card. If further inputs are needed, the input card WCA 8KI (requires the motor line card) can be added. This card has ten local inputs.

The touch screen has an overview of the local inputs.

15.6.1 Numbering of local inputs

All local inputs are numbered.

The number of the input depends on its location on a card - see overview below.

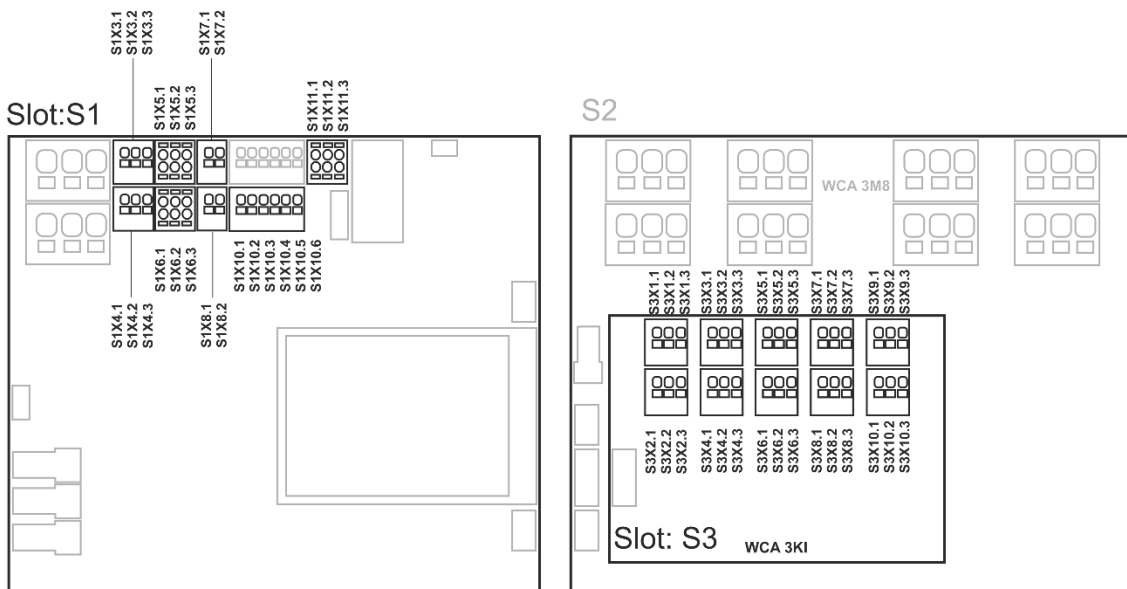

Smoke ventilation panel with input card

15.6.2 Local input - configuration

If component are installed in one or more inputs, these inputs are to be configured. Which item to be configured depends on the type of input – see description below.

Local input - configuration																									
<div style="border: 1px solid black; padding: 5px;"> <p> Configuration, Local input</p> <table border="1" style="width: 100%; border-collapse: collapse; text-align: center;"> <tr> <td style="width: 16.6%;">-</td> <td style="width: 16.6%;">S1 X7.x Smoke</td> <td style="width: 16.6%;">S1 X10.x Safety</td> <td style="width: 16.6%;">S1 X3.1</td> <td style="width: 16.6%;">S1 X3.2</td> <td style="width: 16.6%;">S1 X4.1</td> </tr> <tr> <td>S1 X4.2</td> <td>S1 X8.x</td> <td>S1 Close</td> <td>S1 Open</td> <td>S3 X1.1</td> <td>S3 X1.2</td> </tr> <tr> <td>S3 X2.1</td> <td>S3 X2.2</td> <td>S3 X3.1</td> <td>S3 X3.2</td> <td>S3 X4.1</td> <td>S3 X4.2</td> </tr> <tr> <td>S3 X5.1</td> <td>S3 X5.2</td> <td>S3 X6.1</td> <td>S3 X6.2</td> <td>S3 X7.1</td> <td>S3 X7.2</td> </tr> </table> <p style="text-align: center;"> </p> <p style="text-align: center;">Overview 'Local input'</p> </div>	-	S1 X7.x Smoke	S1 X10.x Safety	S1 X3.1	S1 X3.2	S1 X4.1	S1 X4.2	S1 X8.x	S1 Close	S1 Open	S3 X1.1	S3 X1.2	S3 X2.1	S3 X2.2	S3 X3.1	S3 X3.2	S3 X4.1	S3 X4.2	S3 X5.1	S3 X5.2	S3 X6.1	S3 X6.2	S3 X7.1	S3 X7.2	<p>Example of overview 'Local input' with connected input card (WCA 3KI)</p>
-	S1 X7.x Smoke	S1 X10.x Safety	S1 X3.1	S1 X3.2	S1 X4.1																				
S1 X4.2	S1 X8.x	S1 Close	S1 Open	S3 X1.1	S3 X1.2																				
S3 X2.1	S3 X2.2	S3 X3.1	S3 X3.2	S3 X4.1	S3 X4.2																				
S3 X5.1	S3 X5.2	S3 X6.1	S3 X6.2	S3 X7.1	S3 X7.2																				
<div style="border: 1px solid black; padding: 5px;"> <p> Configuration, Local input</p> <table border="1" style="width: 100%; border-collapse: collapse; text-align: center;"> <tr> <td style="width: 16.6%;">S3 X8.1</td> <td style="width: 16.6%;">S3 X8.2</td> <td style="width: 16.6%;">S3 X9.1</td> <td style="width: 16.6%;">S3 X9.2</td> <td style="width: 16.6%;">S3 X10.1</td> <td style="width: 16.6%;">S3 X10.2</td> </tr> <tr> <td>S3 Close</td> <td>S3 Open</td> <td colspan="4"></td> </tr> </table> <p style="text-align: center;"> </p> <p style="text-align: center;">Overview 'Local input' - more</p> </div>	S3 X8.1	S3 X8.2	S3 X9.1	S3 X9.2	S3 X10.1	S3 X10.2	S3 Close	S3 Open					<p>“S3 Close” and “S3 Open” are the two buttons on the board.</p>												
S3 X8.1	S3 X8.2	S3 X9.1	S3 X9.2	S3 X10.1	S3 X10.2																				
S3 Close	S3 Open																								
<div style="border: 1px solid black; padding: 5px;"> <p> Configuration, Local input</p> <p>Control motor groups 1 2 3 4 5 6 7 8 9 10</p> <p>Control smoke zones -</p> <p style="text-align: center; margin-top: 20px;"></p> </div>	<p>Pressing “-” in the “Local Input” menu, the status of the local and Master safety signal are shown.</p> <p>Used to associate Master Safety signal to Motor groups.</p>																								
Local inputs are to be configured in:																									
<div style="border: 1px solid black; padding: 5px;"> <p> Configuration, Local input, Smoke X7.x</p> <p>Input type Smoke detector</p> <p>Control smoke zones -</p> <p>Active state On</p> <p>Threshold: Short-circuit error 500 mV</p> <p style="text-align: center; margin-top: 10px;"></p> <p style="text-align: center;">Configuration of local input on X7</p> </div>	<p>Input X7 on WCA 3SP (smoke detector)</p> <p>If a smoke detector is connected in the local input X7 on the WCA 3SP card, it shall be configured in:</p> <ol style="list-style-type: none"> 1. Input type: informs the type “smoke detector” (<i>not to be configured</i>) 2. Control smoke zones <ol style="list-style-type: none"> 2.1 Function in controlled smoke zones (<i>displayed only if 'Control smoke zones' is selected</i>) 3. Active state 4. Threshold short-circuit error <p>The appendix contains all the items that can be configured - see appendix for detailed explanation.</p>																								

<div style="border: 1px solid black; padding: 5px;"> <div style="display: flex; align-items: center;"> ✓ Configuration, Local input, X3.1 </div> <table style="width: 100%; border-collapse: collapse;"> <tr> <td style="width: 60%;">Input type</td> <td style="text-align: center;">Binary</td> </tr> <tr> <td>Control smoke zones</td> <td style="text-align: center;">-</td> </tr> <tr> <td>Control motor groups</td> <td style="text-align: center;">-</td> </tr> <tr> <td>Active state</td> <td style="text-align: center;">On</td> </tr> </table> <div style="display: flex; justify-content: space-between; margin-top: 5px;"> <div style="border: 1px solid black; padding: 2px; width: 20px; height: 20px; text-align: center;">↶</div> <div style="border: 1px solid black; padding: 2px; width: 20px; height: 20px; text-align: center;">↓</div> </div> <p style="font-size: small; margin-top: 5px;">Configuration of local input X3 and X4</p> </div>	Input type	Binary	Control smoke zones	-	Control motor groups	-	Active state	On	<p>Input X3 and X4 on WCA 3SP and X1-X10 on WCA 8KI (binary) If local inputs are connected on the card/cards WCA 3SP and/or WCA 8KI, it/they shall be configured in:</p> <ol style="list-style-type: none"> 1. Input type: informs the type of the input "Binary" (not to be configured) 2. Control smoke zones* <ol style="list-style-type: none"> 2.1 Function in controlled smoke zones (<i>displayed only if 'Control smoke zones' is selected</i>) 3. Control motor groups* <ol style="list-style-type: none"> 3.1 Function in controlled motor groups 3.2 Short output function 4. Active state 5. Thresholds configuration <p style="font-size: x-small; margin-top: 5px;">* The input can either control smoke zones or motor groups. When one is selected the other option will disappear from the touch screen.</p> <p>The appendix contains all the items that can be configured - see appendix for detailed explanation.</p>
Input type	Binary								
Control smoke zones	-								
Control motor groups	-								
Active state	On								

<div style="border: 1px solid black; padding: 5px;"> <div style="display: flex; align-items: center;"> ✓ Configuration, Local input, X8.x </div> <table style="width: 100%; border-collapse: collapse;"> <tr> <td style="width: 60%;">Input type</td> <td style="text-align: center;">24/48V</td> </tr> <tr> <td>Control smoke zones</td> <td style="text-align: center;">-</td> </tr> <tr> <td>Active state</td> <td style="text-align: center;">On</td> </tr> </table> <div style="display: flex; justify-content: space-between; margin-top: 5px;"> <div style="border: 1px solid black; padding: 2px; width: 20px; height: 20px; text-align: center;">↶</div> </div> <p style="font-size: small; margin-top: 5px;">Configuration of local input X8 on the WCA 3SP card</p> </div>	Input type	24/48V	Control smoke zones	-	Active state	On	<p>Input X8 on WCA 3SP (24V/48V) (primary used in France) If there is connection in X8 on the card WCA 3SP, it shall be configured in:</p> <ol style="list-style-type: none"> 1. Input type informs the type "24/48V" (<i>not to be configured</i>) 2. Control smoke zones <ol style="list-style-type: none"> 2.1 Function in controlled smoke zones (displayed only if 'Control smoke zones' is selected) 3. Active state <p>The appendix contains all the items that can be configured - see appendix for detailed explanation.</p>
Input type	24/48V						
Control smoke zones	-						
Active state	On						

15.6.3 Usage of wind/rain sensors - WLA 33x

Usage of wind/rain sensors WLA 33x with motor groups (MG):									
<div style="border: 1px solid black; padding: 5px;"> <div style="display: flex; align-items: center;"> ✓ Configuration, Local input, Safety X10.5 </div> <table style="width: 100%; border-collapse: collapse;"> <tr> <td style="width: 60%;">Input type</td> <td style="text-align: center;">Binary</td> </tr> <tr> <td>Control motor groups</td> <td style="text-align: center;">1</td> </tr> <tr> <td>Active function in controlled motor groups</td> <td style="text-align: center;">-</td> </tr> <tr> <td>Inactive function in controlled motor groups</td> <td style="text-align: center;">-</td> </tr> </table> <div style="display: flex; justify-content: space-between; margin-top: 5px;"> <div style="border: 1px solid black; padding: 2px; width: 20px; height: 20px; text-align: center;">↶</div> <div style="border: 1px solid black; padding: 2px; width: 20px; height: 20px; text-align: center;">↓</div> </div> </div>	Input type	Binary	Control motor groups	1	Active function in controlled motor groups	-	Inactive function in controlled motor groups	-	<p>The used input e.g., S1X10.5 is configured to "Control motor groups", the groups are chosen. Then, in the menu "Active function in controlled motor groups" the function "Safety" is selected. Then, a function for the motor group when inactive can be selected "Inactive function in the controlled motor groups".</p> <p>By each motor group it is possible to define the max opening for "Safety", meaning it is possible to allow windows and louvers inside the building to open despite "Safety" (wind/rain).</p> <p>Facade windows, which are allowed to open e.g., 10%, to open despite it rains.</p>
Input type	Binary								
Control motor groups	1								
Active function in controlled motor groups	-								
Inactive function in controlled motor groups	-								

Input shall be configured in:									
<div style="border: 1px solid black; padding: 5px;"> <div style="display: flex; align-items: center;"> ✓ Configuration, Local input, S1X10.5 Safety: Active function in controlled </div> <table style="width: 100%; border-collapse: collapse;"> <tr> <td style="width: 50%; text-align: center;">-</td> <td style="text-align: center;">Open</td> </tr> <tr> <td style="text-align: center;">Close</td> <td style="text-align: center;">Stop</td> </tr> <tr style="background-color: #c8e6c9;"> <td style="text-align: center;">Safety</td> <td style="text-align: center;">Comfort open</td> </tr> <tr> <td style="text-align: center;">Comfort step</td> <td style="text-align: center;">Auto. position</td> </tr> </table> <div style="display: flex; justify-content: space-between; margin-top: 5px;"> <div style="border: 1px solid black; padding: 2px; width: 20px; height: 20px; text-align: center;">✕</div> <div style="border: 1px solid black; padding: 2px; width: 20px; height: 20px; text-align: center;">✓</div> <div style="border: 1px solid black; padding: 2px; width: 20px; height: 20px; text-align: center;">↓</div> </div> <p style="font-size: small; margin-top: 5px;">Configuration of local input</p> </div>	-	Open	Close	Stop	Safety	Comfort open	Comfort step	Auto. position	<ol style="list-style-type: none"> 1. In the motor groups configure the input with the function "Safety". 2. Configure the motor groups when anything else than close (0%) is desired. <p>Note: motor groups also receive "Safety" signals from the smoke zones they are associated with, see below for further information.</p>
-	Open								
Close	Stop								
Safety	Comfort open								
Comfort step	Auto. position								

Usage of wind/rain sensors WLA 33x with smoke zones (SZ):

Configuration, Local input, Safety X10.5

Input type Binary

Control smoke zones

Function in controlled smoke zones

Inactive function in controlled smoke zones

The used input e.g., S1X10.5 is configured as “Control smoke zones” with the function “Comfort safety”

When an input is configured as “Smoke zones” and “Comfort safety” has been selected, there must in the configuration of all the motor groups be selected “Yes” to “Use ‘safety’ from smoke zone”.

If there in the configuration of the smoke zone has been chosen a slave-smoke zone, safety information is automatically transmitted to the slave smoke zone.

Input shall be configured in:

Configuration, Local input, Smoke X7.x: Function in controlled smoke

-	Line A	Line B	Reset
Line C	Line D	Line E	Line F
Comfort stop	Comfort open	Comfort close	Comfort safety <input checked="" type="checkbox"/>

Configure the input with “Comfort safety” as “Function in controlled smoke zones”.

Configuration, Motor group, no. 1

Controlling smoke zone

Comfort open position

Comfort open close time

Use 'safety' from smoke zone

1. Configure the motor groups to “Use ‘safety’ from smoke zone” = Yes.
2. Configure if needed also the motor groups in the slave zones with “Use ‘safety’ from smoke zone” = Yes.

Note: when associating an Input with “Safety comfort” function with either a motor group or a smoke zone, all smoke zones will receive a “Local Safety” signal.

If a motor group associated with a smoke zone, should not react to safety signals, you have to configure the motor group with “Use ‘safety’ from Smoke zone” = No.

15.7 Local output

On the WCA 3SP card the smoke ventilation panel always has one output (X9.1 / X9.2) for fault signal to Fire Alarm System (not configurable output).

15.7.1 Numbering of local output

All local outputs on the WCA 3SP card are numbered.

The number of the output depends on its location on the card - see overview below.

As the output (fault signal to Fire Alarm System) on the WCA 3SP card cannot be configured it is not numbered.

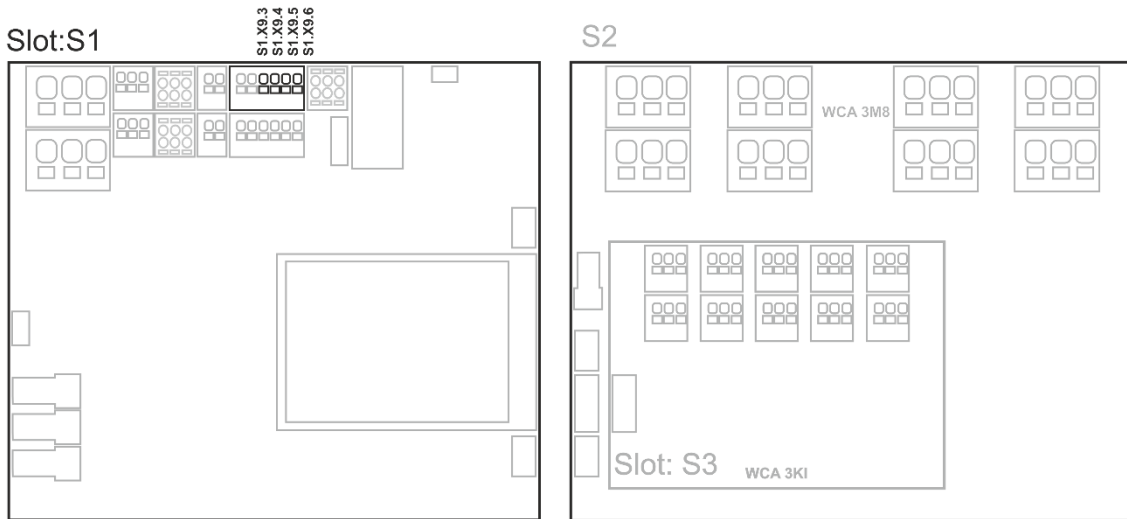

Smoke ventilation panel with motor line and input cards

15.7.2 Local output - configuration

If component are installed in one or more outputs, these outputs are to be configured.

Which item to be configured depends on the type of output – see description below.

Local output - overview			
<div style="border: 1px solid black; padding: 5px;"> <p><input checked="" type="checkbox"/> Configuration, Local output</p> <table border="1" style="width: 100%; border-collapse: collapse;"> <tr> <td style="width: 50%; text-align: center;">A X9.3/4</td> <td style="width: 50%; text-align: center;">B X9.5/6</td> </tr> </table> <div style="text-align: right; margin-top: 10px;"> </div> </div> <p style="text-align: center;">Overview 'Local output'</p>	A X9.3/4	B X9.5/6	<p>Overview 'Local output'</p>
A X9.3/4	B X9.5/6		
Local output shall be configured in:			
<div style="border: 1px solid black; padding: 5px;"> <p><input checked="" type="checkbox"/> Configuration, Local output, A X9.3/4</p> <p>Output type Binary output</p> <p>Output mode Binary output</p> <p>Controlled by smoke zones -</p> <p>Controlled by motor groups -</p> <div style="text-align: right; margin-top: 10px;"> </div> </div> <p style="text-align: center;">Configuration of a local output (shown for S1 X9.3/4)</p>	<ol style="list-style-type: none"> 1. Output type: informs the type 'Binary output' (is <i>not</i> to be configured) 2. Output mode <ol style="list-style-type: none"> 2.1 Controlled by smoke zones (<i>displayed only when 'Siren' is selected</i>) 2.2 Time out 2.3 Smoke zones output functions 3. Controlled by smoke zones* (<i>displayed only when 'output mode is selected to 'Binary output'</i>) <ol style="list-style-type: none"> 3.1 Smoke zone output functions 3.2 Logic function 3.3 Status when active 3.4 Time out 4. Controlled by motor groups <ol style="list-style-type: none"> a) Motor group output function b) Logic function c) Status when active d) Time-out <p>* The output can either control smoke zones or motor groups. When one is selected the other option will disappear from the touch screen.</p> <p>The appendix contains all the items that can be configured - see appendix for detailed explanation.</p>		

15.8 Weather station type

Here is to be selected which type of weather station –none, WOW or WLA - that is connected.

(The menu “Weather” is only used for input from WCA 3SP input S1X10.2 for wind speed from WLA 340. Input S1X10.2 is also used in combination with weather station WOW 201/202/204 or WOW 600 for wind direction dependent smoke ventilation - see section 11.4 in the installation instruction).

WLA 33x is not considered as a weather station and is connected directly to the input X10.5, see section 15.6.3

Weather - configuration																					
<div style="border: 1px solid black; padding: 5px;"> <div style="display: flex; align-items: center;"> ✓ Configuration, Weather </div> <div style="margin-top: 10px;"> <p>Sensor type None</p> <p>WSK Link™ Master present Master not present</p> <div style="border: 1px solid black; width: 40px; height: 20px; margin-top: 10px; display: flex; align-items: center; justify-content: center; margin-left: 10px;"> ➡ </div> </div> <p style="text-align: center; margin-top: 5px;">Overview 'Sensor type'</p> </div>	<p>Overview 'Sensor type' (selection of type of weather station).</p> <p>If several WSC 3x0 panels are connected via a WSK-Link™, the WSK-Link™ allows the panels to share weather data. The panel with the connected weather station will be the master. The first time a slave panel discovers a master panel, the “WSK-Link™ Master present” will become true.</p> <p>In the slave panels “Sensor type” should subsequently be set to “WSK-Link™” in order for them to receiver weather data from the master.</p>																				
Weather shall be configured in:																					
<div style="border: 1px solid black; padding: 5px;"> <div style="display: flex; align-items: center;"> ✓ Configuration, Weather: Sensor type </div> <table border="1" style="width: 100%; text-align: center; border-collapse: collapse;"> <tr> <td style="border: none;">None ✓</td> <td style="border: none;">WOW</td> <td style="border: none;">WLA 340</td> <td style="border: none;">From WSK Link™</td> </tr> <tr> <td style="border: none;">WOW 600</td> <td style="border: none;">WOW from A0net</td> <td style="border: none;">WLA 340 from A0net</td> <td style="border: none;">WOW 600 from A0net</td> </tr> <tr> <td style="border: none;">WOW from foreign</td> <td style="border: none;">WLA 340 from</td> <td style="border: none;">WOW 600 from</td> <td style="border: none;">From fieldbus</td> </tr> <tr> <td style="border: none;">Fieldbus from A0net</td> <td style="border: none;">Fieldbus from</td> <td colspan="2" style="border: none;"></td> </tr> <tr> <td style="border: none;">✗</td> <td style="border: none;">✓</td> <td colspan="2" style="border: none;"></td> </tr> </table> <p style="text-align: center; margin-top: 5px;">Configuration of the sensor</p> </div>	None ✓	WOW	WLA 340	From WSK Link™	WOW 600	WOW from A0net	WLA 340 from A0net	WOW 600 from A0net	WOW from foreign	WLA 340 from	WOW 600 from	From fieldbus	Fieldbus from A0net	Fieldbus from			✗	✓			<p>None (no configuration)</p> <p>WOW</p> <ol style="list-style-type: none"> 1. Filter constant 2. Slow filter constant 3. Use RMS in filter <p>WLA</p> <ol style="list-style-type: none"> 1. Pulses/sec. per m/s 2. Filter constant 3. Slow filter constant 4. Use RMS in filter <p>From WSK Link™ (no configuration)</p> <p>Only to be set in slave panels connected to a master panel with connected weather station.</p> <p>WOW 600 (only panel version 4 or 6)</p> <ol style="list-style-type: none"> 1. Filter constant 2. Slow filter constant 3. Use RMS in filter <p>X from A0net or foreign (only panel version 2, 4 or 6)</p> <p>A0net eller foreign is only used in connection with NV Embedded®, please refer to the NV Embedded® instruction for further details.</p> <p>The appendix contains all the items that can be configured - see appendix for detailed explanation.</p>
None ✓	WOW	WLA 340	From WSK Link™																		
WOW 600	WOW from A0net	WLA 340 from A0net	WOW 600 from A0net																		
WOW from foreign	WLA 340 from	WOW 600 from	From fieldbus																		
Fieldbus from A0net	Fieldbus from																				
✗	✓																				

15.9 Sequence control

The sequence control functionality is used where the movement of a motor line must depend on an external event or situation/stage.

To be used where window flabs are overlapping or where the windows cannot open (more than 15%) if the blinds are down a.s.o.

The sequence control can be controlled depending on;

- the position of a different motor line
- the state of a local input
- the state of a KNX object
- the state of a BACnet object

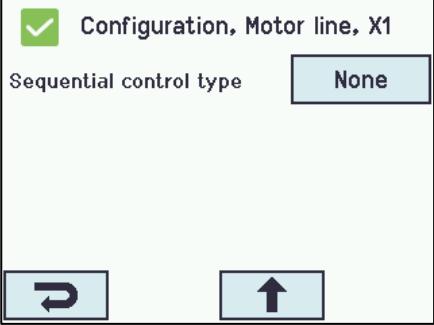
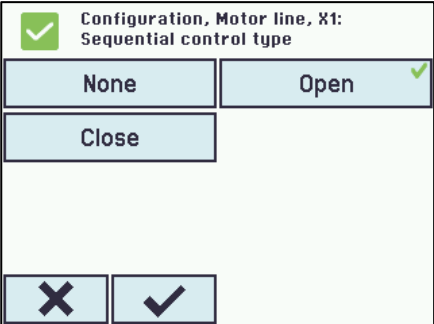
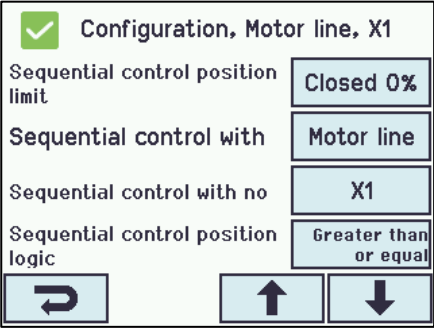
Sequence control configuration	
 <p>Configuration, Motor line, X1 Sequential control type: None</p> <p>Activation of sequence control</p>	<p>The activation of sequence control is to be done for each motor line.</p>
 <p>Configuration, Motor line, X1: Sequential control type</p> <p>None, Open, Close</p> <p>Sequence control configuration</p>	<p>The function for the sequence control is to be configured for each motor line</p> <ol style="list-style-type: none"> None - This motor line does not use sequence control Open - This motor line must wait for a “result” before opening Close - This motor line must wait for a “result” before closing
Sequence control configuration – motor line	
 <p>Configuration, Motor line, X1</p> <p>Sequential control position limit: Closed 0%</p> <p>Sequential control with: Motor line</p> <p>Sequential control with no: X1</p> <p>Sequential control position logic: Greater than or equal</p>	<ol style="list-style-type: none"> Sequential control position limit the max position the motor line is allowed to have without the „result“ is being fulfilled. For MotorLink® motor lines stepless variable. For ±24 Volt motor lines 0 or 100% Sequential control with (<i>upon what should the motor line wait?</i>) <ol style="list-style-type: none"> Motor line. Local input The state of a KNX object The state of a BACnet object Sequential control with No Upon which number should the motor line wait Sequential control position logic In which positions should the sequential control be active

15.10 Magnetic clamp (magnetic door retainer)

Motor lines (only ±24 Volt motor output) can be defined as magnetic clamps.

Per panel up to max. 6A for WSC 320 and max. 3A for WSC 310 can be used for magnetic clamps, the remaining 14A and 7A respectively are reserved for motors.

If a motor line is defined as magnetic clamp there will be power on the output as long as the panel is not triggered in fire condition. If a motor line is defined as a magnetic clamp there will be no need of cable monitoring, as a cable error will have the same function as fire condition. The cable monitoring can be selected if an error on the cables is to be shown.

Note, in case of mains power failure, the output will also lose its power and the magnetic clamp will release the door.

Technical data:

- Power consumption per magnetic clamp: minimum 5mA
- Current for magnetic clamp: maximum 6A for WSC 320 and maximum 3A for WSC 310

The CompactSmoke™ is tested with Hekatron THM 425-1. Technical data (of Hekatron):

Technische Daten/Caractéristiques techniques/Technical data

24 V DC	Betriebsnennspannung	Tension nominale de service	Nominal operating voltage
63 mA	Stromaufnahme	Intensité du courant d'utilisation	Current consumption
1,5 W	Leistungsaufnahme	Puissance absorbée	Power consumption
1372 N	Haftkraft	Force d'attraction	Holding force
100 %	Einschaltdauer	Régime permanent	Continuous rating
0 bis/jusque/to +50 °C	Betriebsumgebungstemperatur	Température ambiante de service	Ambient operating temperature
IP 40	Schutzart	Type de protection	Ingress protection
1,0 kg	Gewicht	Poids	Weight

Configuration of magnetic clamp											
<div style="border: 1px solid black; padding: 5px;"> <p><input checked="" type="checkbox"/> Configuration, Motor line, S1 X1: Motor configuration</p> <table border="1" style="width: 100%; border-collapse: collapse;"> <tr> <td style="width: 50%; text-align: center;">None</td> <td style="width: 50%;">No cable monitoring</td> </tr> <tr> <td style="text-align: center;">3 wire cable monitoring</td> <td style="text-align: center;">Magnetic clamp <input checked="" type="checkbox"/></td> </tr> <tr> <td style="text-align: center;">Magnetic clamp, 3 w. surveillance</td> <td style="text-align: center;">Not set</td> </tr> <tr> <td colspan="2" style="text-align: center;">Alarm output</td> </tr> <tr> <td style="text-align: center;"><input checked="" type="checkbox"/></td> <td style="text-align: center;"><input type="checkbox"/></td> </tr> </table> <p style="text-align: center;">Configuration of magnetic clamp</p> </div>	None	No cable monitoring	3 wire cable monitoring	Magnetic clamp <input checked="" type="checkbox"/>	Magnetic clamp, 3 w. surveillance	Not set	Alarm output		<input checked="" type="checkbox"/>	<input type="checkbox"/>	<p>The configuration of magnetic clamp must be done for each motor line.</p> <p>Under the configuration of Motors line select Magnetic clamp.</p>
None	No cable monitoring										
3 wire cable monitoring	Magnetic clamp <input checked="" type="checkbox"/>										
Magnetic clamp, 3 w. surveillance	Not set										
Alarm output											
<input checked="" type="checkbox"/>	<input type="checkbox"/>										
<div style="border: 1px solid black; padding: 5px;"> <p><input checked="" type="checkbox"/> Configuration, Motor line, X1</p> <p>Output mode: ±24V motor</p> <p>Motor configuration: Magnetic clamp</p> <p>Motor group: -</p> <p>Manual command – auto. off period: 30 min.</p> <p style="text-align: center;"><input checked="" type="checkbox"/> <input type="checkbox"/></p> </div>	<p>Each motor line which is configured to a magnetic clamp must be associated with a motor group.</p>										

15.11 Pyrotechnic gas generator

A pyrotechnic gas generator is a pyrotechnic detonator which is now supported on the ±24 Volt motor line outputs on the WCA 3SP and the WCA 3M8 cards.

A pyrotechnic gas generator is only supported by smoke panels version E4 and E6.

Typical data:

- Resistor: 1.4 to 1.7 Ohm
- 100% no ignition: 180 mA / 5 min. DC
- 100% ignition: 600 mA / 10 ms (DC)
- Test current: max: 10 mA

The CompactSmoke™ is tested with Chemring Typ 1.3.

Configuration of pyrotechnic gas generator											
<div style="border: 1px solid black; padding: 5px;"> <p><input checked="" type="checkbox"/> Configuration, Motor line, X1: Motor configuration</p> <table border="1" style="width: 100%; border-collapse: collapse;"> <tr> <td style="width: 50%; text-align: center;">None</td> <td style="width: 50%;">No cable monitoring</td> </tr> <tr> <td style="text-align: center;">3 wire cable monitoring</td> <td style="text-align: center;">Magnetic clamp</td> </tr> <tr> <td style="text-align: center;">Magnetic clamp, 3 w. surveillance</td> <td style="text-align: center;">Not set</td> </tr> <tr> <td style="text-align: center;">Pyrotechnic gas generator <input checked="" type="checkbox"/></td> <td></td> </tr> <tr> <td style="text-align: center;"><input checked="" type="checkbox"/></td> <td style="text-align: center;"><input type="checkbox"/></td> </tr> </table> <p style="text-align: center;">Configuration of pyrotechnic gas generator</p> </div>	None	No cable monitoring	3 wire cable monitoring	Magnetic clamp	Magnetic clamp, 3 w. surveillance	Not set	Pyrotechnic gas generator <input checked="" type="checkbox"/>		<input checked="" type="checkbox"/>	<input type="checkbox"/>	<p>The configuration of pyrotechnic gas generators must be done for each motor line.</p> <p>When a motor line is configured as pyrotechnic gas generator:</p> <ul style="list-style-type: none"> - it will not react on comfort commands - the cable monitoring will detect cable interruption - NO end of line motor modules (WSA 501 / 510) is to be inserted - motor line must be configured as pyrotechnic gas generator BEFORE the generator is connected! <p>When more pyrotechnic gas generators are to be connected on the same motor line they (max. 5 pcs) are to be connected in series.</p>
None	No cable monitoring										
3 wire cable monitoring	Magnetic clamp										
Magnetic clamp, 3 w. surveillance	Not set										
Pyrotechnic gas generator <input checked="" type="checkbox"/>											
<input checked="" type="checkbox"/>	<input type="checkbox"/>										

For dimensioning of cable see section 9.2.4

15.12 Master / Slave connection of smoke zones

The master/slave connection between two panels is done via input X5 or X6 on the master panel – the input, also used for connection to a break glass unit – and input X11 on the slave panel.

The Master/Slave connection is configured in the WSK-Link™ menu.

A smoke panel can have a master/slave connection to several smoke panels. However, the total max number of connected slaves AND break glass units on the bus must not exceed 10 units.

The total cable length must not exceed 200m, see examples below for how to connect the panels.

A slave panel can only have one master, whereas a master panel can have several slaves and a panel can both be a slave and a master to other panels.

Example 1 - Bus topology

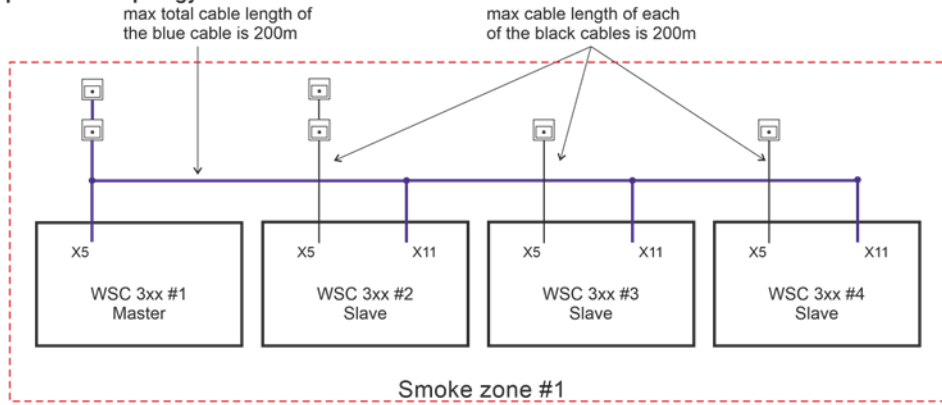

Max 10 units in total (smoke panels + break glass units)

Example 2 - Master-Master/Slave-Slave topology

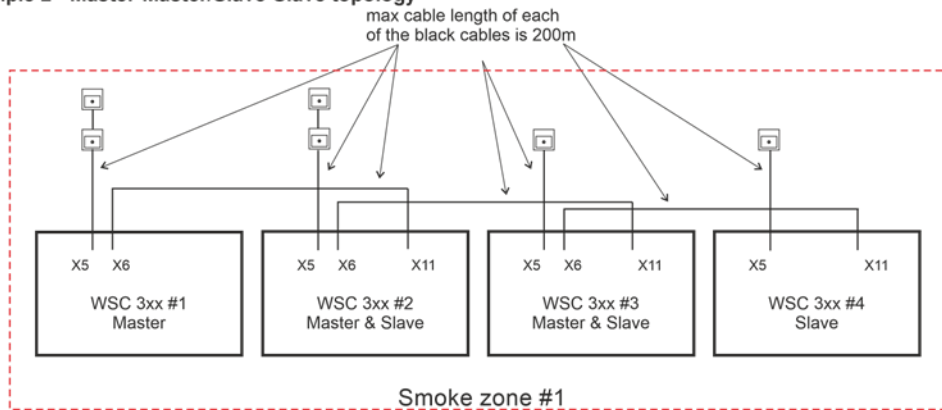

Max 10 units in total (smoke panels + break glass units)
Smoke panel #2 and #3 are both master and slave panels.

Example 3 - Ring topology

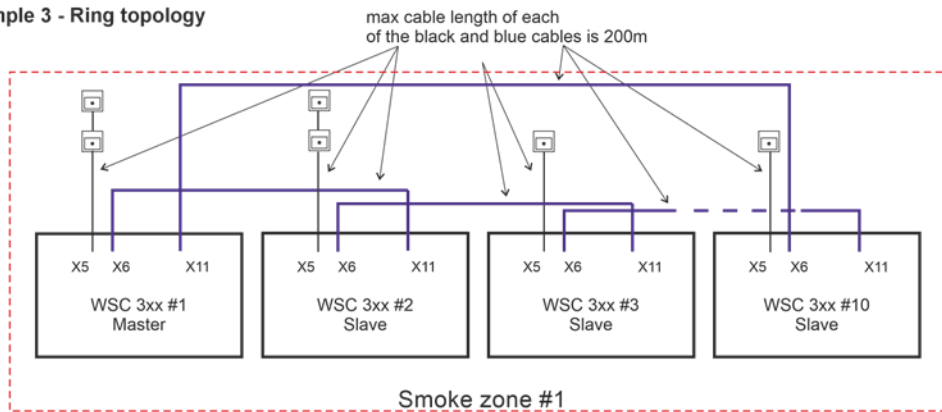

Max 10 units in total (smoke panels + break glass units)
See master-slave configuration for ring connection

When panels are physically connected through the WSK-Link™ (the Master/Slave connection), safety signals and weather data signals are automatically distributed among the connected panels.

Use the [-] button in the “Local Input” menu to associate Motor Groups with a Safety signal coming from the WSK-Link™.

All Motor Groups are associated with this signal as a default.

All smoke zones are automatically associated with the safety signal, this include smoke zones, which are independent from the master-slave setup. If a motor group associated with a smoke should not react to safety signals, you have to configure the motor group with “Use ‘Safety’ from Smoke zone” = ‘No’ “.

Select “From WSK-Link™” in the “Weather” “Sensor type” menu to be able to use wind speed and wind direction signals coming from the Master panel.

Configuration of Master – Slave system:

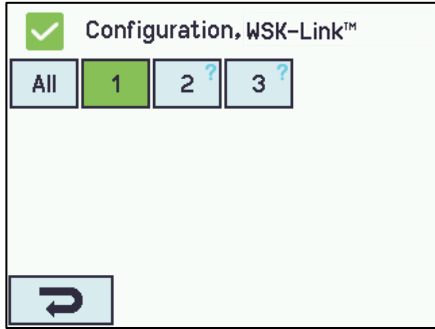

A connected slave panel is shown on the master panel's touch screen.

When two panels are connected to each other in a master-slave connection, the slave panel will appear as a green WSK-Link™ unit on the master's touch screen.

Connected panels (#1) are always shown before connected break glass units (#2 & #3).

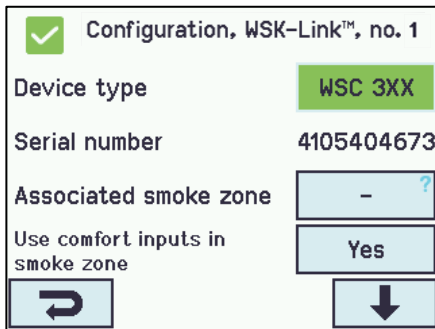

The slave panel's appearance on the master panel

On the master's touch screen the Device type of the slave will appear as a WSC 3xx.

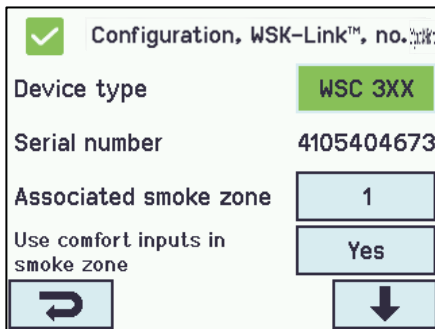

Configuration of master slave connection on master panel

To associate the slave panel with a smoke zone enter the smoke zone on the master panel.

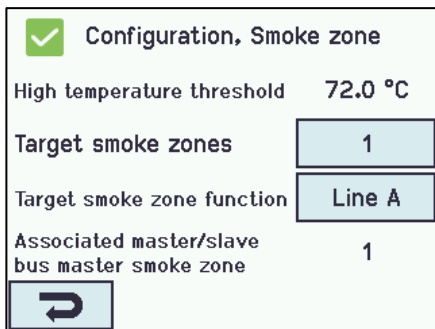

The associated smoke zone on the slave panel

The smoke zone will immediately be sent to the slave panel.

Master-Slave Ring topology shall be configured in:	
<div style="border: 1px solid black; padding: 5px;"> <p><input checked="" type="checkbox"/> View all details, Smoke zone</p> <p>Target smoke zone function Line A</p> <p>Target smoke zone output <...></p> <p>Alarm / reset input <...></p> <p>WSK-Link™ configured as ring Yes</p> <p style="text-align: center;"> <input type="button" value="↶"/> <input type="button" value="↑"/> <input type="button" value="↓"/> </p> </div> <p style="text-align: center;">Configuration of Master-Slave Ring topology</p>	<p>In the menu 'All details' → 'Smoke zone' → 'All'</p> <p>All panels must be configured 'WSK-Link™ configured as ring' = 'Yes'</p>
<div style="border: 1px solid black; padding: 5px;"> <p><input checked="" type="checkbox"/> View all details, Smoke zone</p> <p>Ring Master Yes</p> <p>Associated WSK bus master smoke zone 10</p> <p>Keepalive OK Yes</p> <p>Master/slave bus online Yes</p> <p style="text-align: center;"> <input type="button" value="↶"/> <input type="button" value="↑"/> <input type="button" value="↓"/> </p> </div> <p style="text-align: center;">Configuration of Ring Master</p>	<p>One and only one panel must be configured as 'Ring Master' = 'Yes'.</p> <p>In installations with wind direction dependent smoke ventilation, the Ring Master must be the panel to which the weather station is connected.</p>

Components – break glass units, comfort keypads etc. – connected to the slave panel are configured in the same way components connected to the master or a normal panel.

All signals from components connected to the slave panel are automatically sent to the master panel, which then sends commands (smoke, comfort, and safety) back to the slave panel. The slave panel only reacts to commands from their master, never from its local signals.

Signals from slaves and the master's own connected components are treated on equal terms. To get the fastest response, it is recommended that break glass units are connected to the master.

15.13 Network

For configuring network addresses.

The WCA 3SP card has a 10/100Mbit Ethernet connection. The connection support DHCP or static IP address as well as Gateway

It is possible to configure different power consumption profiles for the Ethernet connection. To burden the 72 hours back-up batteries as little as possible, use the setting 'Off' or 'Auto' (factory setting).

The appendix contains all the items that can be configured - see appendix for detailed explanation.

Network is used in with BACnet IP interface – contact WindowMaster for further information.

Network shall be configured in:	
<div style="border: 1px solid black; padding: 5px;"> <p><input checked="" type="checkbox"/> Configuration, Network</p> <p>DHCP Yes</p> <p>Power setting Auto.</p> <p style="text-align: center;"> <input type="button" value="↶"/> </p> </div> <p style="text-align: center;">Configuration of 'Network'</p>	<ol style="list-style-type: none"> 1. DHCP 2. Power setting <p>The appendix contains all the items that can be configured - see appendix for detailed explanation.</p>

15.13.1 AOnet

AOnet – addressable objects network - is a network, which can be used to connect smoke panes type WSC 310/320 Plus and comfort panels type WCC 310 / 320 Plus. The AOnet allows the sharing of weather data and time synchronization

15.14 Log in

The access level to the smoke ventilation panel is set in four levels.

Level	Access to	Who has access
1	<u>Public</u> You can see the smoke ventilation panel from the outside with the door closed and locked	Everyone
2	<u>Operation</u> You can open the panel house and operate the touch screen for showing the status and manual operating of the windows. All the menus on the touch screen can be viewed but no values can be changed.	Chosen persons with a special key
3	<u>Configuration</u> You can open the panel house and operate the touch screen for showing status, manual operating of the windows as well as configuration and changing the pre-set values. All the menus and sub menus can be seen and the values can be changed. Access Level 3 can be locked with a PIN code, so there is only access to the level when the PIN is entered	Chosen persons with a special key and having the PIN code for access to level 3. PIN code pre-set to 4321.

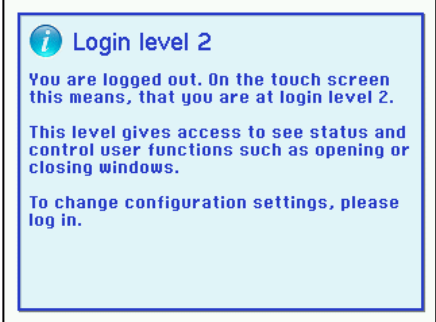
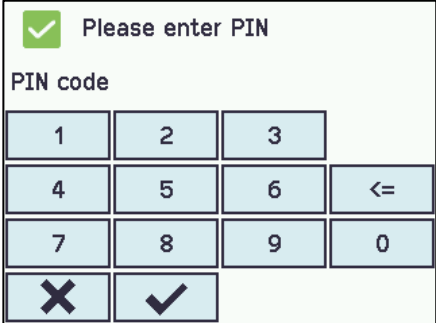
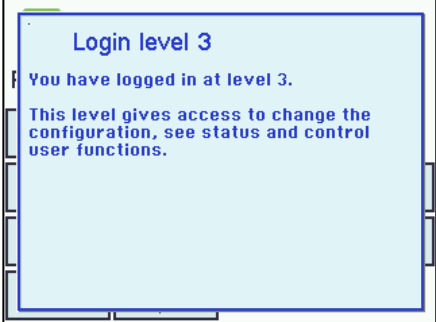
 <p>The user is on access level 2</p>	<p>The user is at access level 2.</p> <p>To open for access level 3, enter the PIN for access level 3.</p>
 <p>Enter PIN code</p>	<p>Enter PIN code.</p>
 <p>Access approved to login level 3</p>	<p>The user is at access level 3.</p>

Login shall be configured in:

Configuration, Login

PIN 3: Configuration

Log out time-out



Configuration of login

The access levels can be locked and access to the level is only possible with a PIN code.

Each level has a unique PIN code.

1. PIN 3: Configuration
2. Log out time-out (the period of access to the level before the system automatically lock the level)

The appendix contains all the items that can be configured - see appendix for detailed explanation.

It is possible to lock the touch screen before the time has expired: press  followed by pressing

15.15 Configuration files on USB

The panel has a plug in for an USB stick. It is possible to save all the configurations of the panel and this way save the stick as documentation. It is also possible to reinstall from the USB stick.

Files on the USB stick can be printed from a computer.

Configuration, Configuration files, USB

1	2	3	4	5	6
7	8	9	10	11	12
13	14	15	16	17	18
19	20	21	22	23	24



Configuration 'Configuration, files on USB' - overview

Configuration files on USB – overview.

Configuration, Configuration files, USB, no. 1

Status No disk



Configuration of 'Configuration files on USB - no.1'.

Configuration of configuration files on USB – shown for no. 1.

15.16 System

It is possible to change settings on the touch screen e.g., language, clock setting, date display, service timer etc.

System can be configured in:



Configuration, System

Language

Backup time stamp

Unsaved changes

Configuration command

 

Configuration of 'System'

1. Language
2. Backup time stamp *(not to be configured)*
3. Unsaved changes... *(not to be configured)*
4. Configuration command
5. Time
6. Date
7. Reset service timer
8. The interval between service
9. LCD rotate view
10. Enable parameter set from network
11. Enable remote control

The appendix contains all the items that can be configured - see appendix for detailed explanation.

15.16.1 Service timer

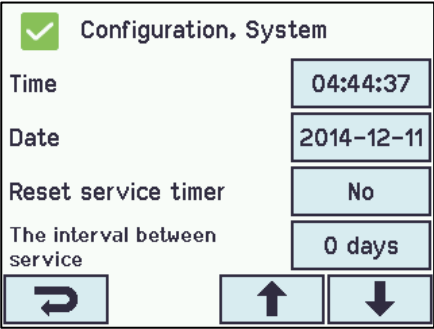
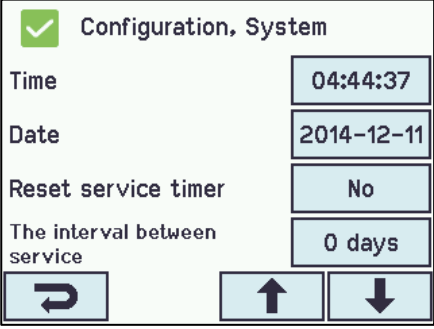
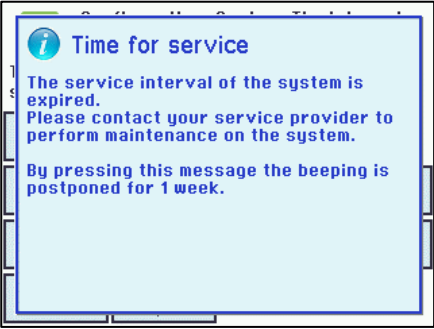
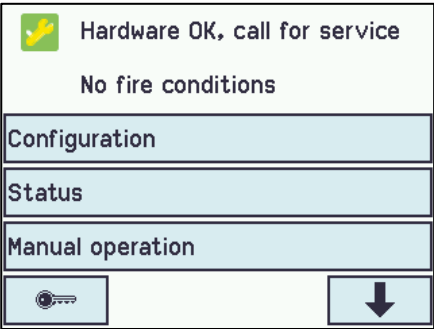
Configuration of interval between maintenance:	
 <p>Reset off service timer</p>	<p>"Reset service timer" set the last maintenance date as today.</p>
 <p>Configuration of interval between service</p>	<p>The timer is set in "The interval between service". Typically, on most markets, this will be 365 days.</p> <p>If the interval between maintenances is set to 0, the timer is disabled.</p> <p>Under "View all details" the acoustic notification can be activated or deactivated.</p>
 <p>Message when the service timer expires</p>	<p>When the service timer expires the touch screen will show a maintenance text and a clear beeping will sound from the panel.</p> <p>Under "View all details" the acoustic notification can be activated or deactivated.</p>
 <p>Main overview when the service timer has been postponed</p>	<p>If you confirm the service timer by touching the touch screen, it will be mute for a week, before the beeping sound starts again.</p> <p>A maintenance icon will appear on the touch screen.</p> <p>Under "View all details" the acoustic notification can be activated or deactivated.</p>

15.17 Fieldbus (KNX and BACnet)

Only when a Fieldbus card with a fieldbus interface is added to the smoke panel will the menus associated with the various fieldbus options be shown.

Fieldbus example	
<div style="border: 1px solid black; padding: 5px;"> <div style="display: flex; align-items: center; margin-bottom: 5px;"> <input checked="" type="checkbox"/> Configuration </div> <div style="border: 1px solid black; padding: 2px; margin-bottom: 2px;">Network</div> <div style="border: 1px solid black; padding: 2px; margin-bottom: 2px;">KNX bus</div> <div style="border: 1px solid black; padding: 2px; margin-bottom: 2px;">BACnet</div> <div style="border: 1px solid black; padding: 2px; margin-bottom: 2px;">Login</div> <div style="display: flex; justify-content: space-between; margin-top: 5px;"> <div style="border: 1px solid black; padding: 2px; width: 20px; text-align: center;">↶</div> <div style="border: 1px solid black; padding: 2px; width: 20px; text-align: center;">↑</div> <div style="border: 1px solid black; padding: 2px; width: 20px; text-align: center;">↓</div> </div> </div>	<p>An optional card with fieldbus interface is added to the panel and the menus (e.g. configuration) now includes KNX and BACnet.</p>

When the Fieldbus card is mounted a set of KNX or BACnet objects are available for each motor line, motor group and smoke zone, which provides the options for status and commands.

Status objects

E.g., actual position, fault and operation status and the max opening angle (degrees).

Command objects

E.g., target position commands with different priority and MotorLink® motor speed.

Fieldbus link - "Conn. 1-10 "

The KNX or BACnet has also 10 configurable binary communication objects.

These can either be used for sending comfort commands to one or more motor groups or to give selected status from smoke zones or motor groups.

See "KNX Application Program Description or "BACnet PICS" on the home pages (www.windowmaster.com) for further information on available KNX or BACnet communication objects.

15.17.1 KNX configuration

KNX bus overview – object configuration													
<div style="border: 1px solid black; padding: 5px;"> <div style="display: flex; align-items: center; margin-bottom: 5px;"> <input checked="" type="checkbox"/> Configuration, KNX bus </div> <table border="1" style="width: 100%; text-align: center; border-collapse: collapse;"> <tr> <td style="width: 10%;">Module</td> <td>Obj. 1</td> <td>Obj. 2</td> <td>Obj. 3</td> <td>Obj. 4</td> <td>Obj. 5</td> </tr> <tr> <td></td> <td>Obj. 6</td> <td>Obj. 7</td> <td>Obj. 8</td> <td>Obj. 9</td> <td>Obj. 10</td> </tr> </table> <div style="border: 1px solid black; padding: 2px; margin-top: 10px; width: 20px; text-align: center;">↶</div> </div>	Module	Obj. 1	Obj. 2	Obj. 3	Obj. 4	Obj. 5		Obj. 6	Obj. 7	Obj. 8	Obj. 9	Obj. 10	<p>Overview of the KNX objects.</p> <p>For each KNX object a direction must be configured</p> <ul style="list-style-type: none"> - None - Input - Output <p>When objects are configured as inputs or outputs, the controlled motor group or smoke zone as well as its function must also be configured.</p>
Module	Obj. 1	Obj. 2	Obj. 3	Obj. 4	Obj. 5								
	Obj. 6	Obj. 7	Obj. 8	Obj. 9	Obj. 10								
KNX bus shall be configured in:													
<div style="border: 1px solid black; padding: 5px;"> <div style="display: flex; align-items: center; margin-bottom: 5px;"> <input checked="" type="checkbox"/> Configuration, KNX bus </div> <table style="width: 100%; border-collapse: collapse;"> <tr> <td style="width: 60%;">Module type</td> <td style="text-align: right;">Konnex</td> </tr> <tr> <td>ETS application version</td> <td style="text-align: right;">3.00</td> </tr> <tr> <td>Physical address</td> <td style="text-align: right;">1.1.1</td> </tr> <tr> <td>Power setting</td> <td style="text-align: right; border: 1px solid black; padding: 2px;">Auto.</td> </tr> </table> <div style="border: 1px solid black; padding: 2px; margin-top: 10px; width: 20px; text-align: center;">↶</div> </div>	Module type	Konnex	ETS application version	3.00	Physical address	1.1.1	Power setting	Auto.	<p>For all the objects the Power setting for the KNX bus must be configured.</p>				
Module type	Konnex												
ETS application version	3.00												
Physical address	1.1.1												
Power setting	Auto.												

15.17.2 BACnet configuration

BACnet overview – object configuration													
<div style="border: 1px solid black; padding: 5px;"> <div style="display: flex; align-items: center;"> ✓ Configuration, BACnet </div> <table border="1" style="width: 100%; border-collapse: collapse; margin-top: 5px;"> <tr> <td style="font-size: 8px;">Com- mon</td> <td style="font-size: 8px;">Obj. 1</td> <td style="font-size: 8px;">Obj. 2</td> <td style="font-size: 8px;">Obj. 3</td> <td style="font-size: 8px;">Obj. 4</td> <td style="font-size: 8px;">Obj. 5</td> </tr> <tr> <td style="font-size: 8px;">Obj. 6</td> <td style="font-size: 8px;">Obj. 7</td> <td style="font-size: 8px;">Obj. 8</td> <td style="font-size: 8px;">Obj. 9</td> <td style="font-size: 8px;">Obj. 10</td> <td></td> </tr> </table> <div style="text-align: right; margin-top: 10px;"> </div> </div>	Com- mon	Obj. 1	Obj. 2	Obj. 3	Obj. 4	Obj. 5	Obj. 6	Obj. 7	Obj. 8	Obj. 9	Obj. 10		<p>Overview of the BACnet objects.</p> <p>For each BACnet object a direction must be configured</p> <ul style="list-style-type: none"> - None - Input - Output <p>When objects are configured as inputs or outputs, the controlled motor group or smoke zone as well as its function must also be configured.</p>
Com- mon	Obj. 1	Obj. 2	Obj. 3	Obj. 4	Obj. 5								
Obj. 6	Obj. 7	Obj. 8	Obj. 9	Obj. 10									
BACnet shall be configured in:													
<div style="border: 1px solid black; padding: 5px;"> <div style="display: flex; align-items: center;"> ✓ Configuration, BACnet </div> <div style="margin-top: 5px;"> <table style="width: 100%; border-collapse: collapse;"> <tr> <td style="font-size: 8px;">BACnet IP UDP port number</td> <td style="border: 1px solid black; text-align: center; font-size: 8px;">47808</td> </tr> <tr> <td style="font-size: 8px;">BACnet IP device instance</td> <td style="border: 1px solid black; text-align: center; font-size: 8px;">1</td> </tr> <tr> <td style="font-size: 8px;">Actual position COV increment</td> <td style="border: 1px solid black; text-align: center; font-size: 8px;">1%</td> </tr> <tr> <td style="font-size: 8px;">Actual max. position COV increment</td> <td style="border: 1px solid black; text-align: center; font-size: 8px;">1%</td> </tr> </table> <div style="display: flex; justify-content: space-between; margin-top: 5px;"> </div> </div> </div>	BACnet IP UDP port number	47808	BACnet IP device instance	1	Actual position COV increment	1%	Actual max. position COV increment	1%	<p>For all the objects</p> <ol style="list-style-type: none"> 1. BACnet IP UDP port number 2. BACnet IP device instance 3. Actual position COV increment 4. Actual max. position COV increment 5. High speed COV increment 6. Wind direction COV increment 7. Register as “foreign device” 				
BACnet IP UDP port number	47808												
BACnet IP device instance	1												
Actual position COV increment	1%												
Actual max. position COV increment	1%												

16 Status – main menu

In 'Status' you can see the status of all the menu items that can be configured under 'Configuration' as well as e.g. the status of the power supply (including mains and battery status) and slots (inform the type of card in the slot).

<div style="border: 1px solid black; padding: 5px;"> <div style="display: flex; align-items: center;"> ✓ Status </div> <div style="margin-top: 5px;"> <table style="width: 100%; border-collapse: collapse;"> <tr><td style="background-color: #e0e0e0;">Motor line</td></tr> <tr><td style="background-color: #e0e0e0;">Motor group</td></tr> <tr><td style="background-color: #e0e0e0;">WSK-Link™</td></tr> <tr><td style="background-color: #e0e0e0;">Smoke zone</td></tr> </table> <div style="display: flex; justify-content: space-between; margin-top: 5px;"> </div> </div> <p style="font-size: 8px; margin-top: 5px;">Main overview: status of the system</p> </div>	Motor line	Motor group	WSK-Link™	Smoke zone	<p>Under ‘Status’ is possible to view the status for:</p> <ol style="list-style-type: none"> 1. Motor line 2. Motor group 3. WSK-Link™ 4. Smoke zone 5. Local input 6. Local output 7. Power supply 8. Network 9. Slots 10. Configuration files, USB 11. System <p>It is not possible to configure the items in 'Status' mode. The appendix contains all the items shown in 'Status' - see appendix for detailed explanation.</p>
Motor line					
Motor group					
WSK-Link™					
Smoke zone					

17 Manual operation – main menu

It is possible to operate the motor lines, the motor groups and the smoke zones direct on the touch screen.

<div style="border: 1px solid black; padding: 5px;"> <div style="display: flex; align-items: center;"> ✓ Manual operation </div> <div style="margin-top: 5px;"> <table style="width: 100%; border-collapse: collapse;"> <tr><td style="background-color: #e0e0e0;">Motor line</td></tr> <tr><td style="background-color: #e0e0e0;">Motor group</td></tr> <tr><td style="background-color: #e0e0e0;">Smoke zone</td></tr> </table> <div style="text-align: right; margin-top: 10px;"> </div> </div> <p style="font-size: 8px; margin-top: 5px;">Main overview: manual operation</p> </div>	Motor line	Motor group	Smoke zone	<p>What to be manually operated:</p> <ol style="list-style-type: none"> 1. Motor line – <i>see text below</i> 2. Motor group 3. Smoke zone
Motor line				
Motor group				
Smoke zone				

Operation types

Motor lines and motor groups

They can be operated **absolutely** (percentage of full open) or **relatively** on the keypad 'open/stop/close' showed on the touch screen.

Smoke zones

They can be operated in 'Alarm' or 'Reset'

Example

Manual operation of a motor line

- If 'All' is selected all the actuators are operated simultaneously.
- If a motor line number is selected only the selected motor line is operated.

<p>Motor line – overview</p>	<p>One motor line is selected</p>	<p>Manual operation on the touch screen</p>
------------------------------	-----------------------------------	---

18 Configuration missing – main menu

If any components, motor lines, motor groups or smoke zones are not configured they are listed here.

If you are logged into access level 3 it is also possible to configure from this menu.

19 Hardware error – main menu

If there are any hardware error on the panel, they will be displayed here.

E.g. if the motor lines are not configured, the main supply is cut of, the back-up batteries are not connected, the type of weather station is not selected etc.

If you are logged into access level 3 it is also possible to configure from this menu.

19.1 Error on the Power supply

Mains power failure will trigger an error on the "Power supply". Within the first minute after the failure has been detected, the green LED in the break glass unit will start to blink. After 30 minutes (parameter setting), the error is indicated on the touch screen and the windows will open (if this has been specified).

Furthermore, non-connected, wrong connected or "dead" batteries can trigger an error on the "Power supply".

<p>Error on the power supply</p>	<p>Error on the Battery status</p>
----------------------------------	------------------------------------

19.1.1 Blown battery fuse – 20A fast

Additionally, an error on the "Battery status" can also be triggered if the fuse (20A fast) is blown.

The fuse is located in bottom left corner of the main card.

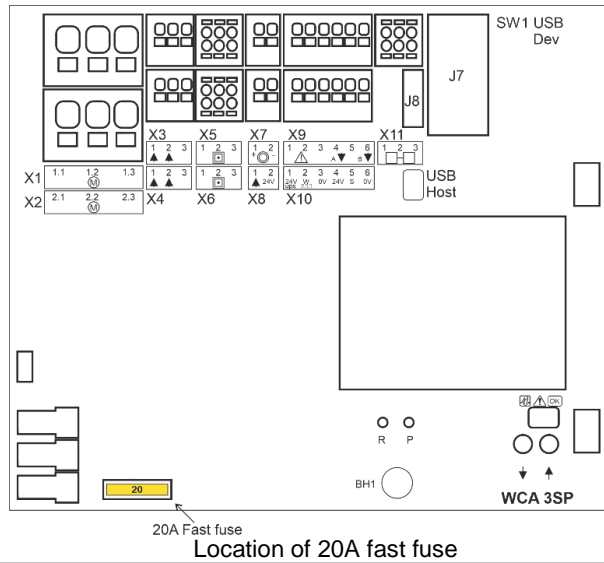

19.1.2 Voltage drop on the vBAT and replacement

<input checked="" type="checkbox"/>	View all details, Power supply
Disable low standby power mode	No
Mains off error time	28 min.
Standby 5V	5.0 V
Vbat	3.2 V
<input type="button" value="↶"/> <input type="button" value="↑"/> <input type="button" value="↓"/>	

If VBAT voltage drops below 1,65 V an vBAT error can be seen in the power supply menu and the battery must be replaced.

vBAT type: 1 pcs. Lithium CR 1220 3V

Replacement:

1. The vBAT battery is located on the main PCB.
2. Turn off 230 V mains and remove 20A backup battery fuse.
3. Remove the main PCB plastic cover by unscrewing the 4 fixing screws
4. Remove the button cell battery by inserting a small screwdriver in the right side of the vBAT. Press firmly to the left and lift.
5. Insert the new battery with the plus side upwards, slide it in on the left side of the holder and press down. Put the plastic cover back.
6. Reconnect all power supplies.
7. Login in and go to "View all detail" – "system" menu and set time and date.

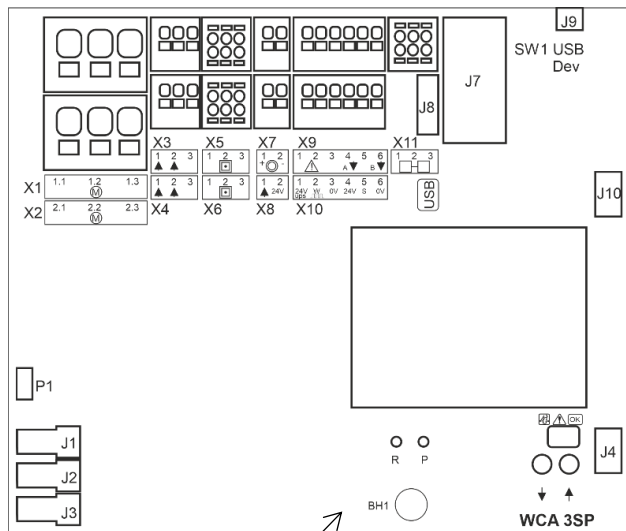

20 View all details – main menu

To make the configuration of the smoke ventilation panel as simple as possible during configuration, it is only possible to configure the most used functions.

Under 'View all details' is displayed all of the above functions together with detailed functions that are not used as often but are possible to configure. If you are logged into access level 3 it is also possible to configure from this menu.

It is possible to view all details for:

- Motor line
- Motor group
- WSK-Link™
- Smoke zone
- Local input
- Local output
- Weather
- Power supply
- Network
- Slots
- Log in
- Configuration files, USB
- System

21 Remote control of CompactSmoke™

It is possible to remote control a CompactSmoke™ from a PC.

When the CompactSmoke™ is on a standard computer network (Ethernet) you can from any PC with the "WMaFlexiSmokeRemote" program control the CompactSmoke™ just like if you were standing in front of the panel. If the CompactSmoke™ is not connected to a network, then it can be remote controlled via a USB connection using the "WMaFlexiSmokeRemote" program.

The program "WMaFlexiSmokeRemote" can be downloaded from our webpages (www.windowmaster.com) under WSC 310 or WSC 320.

Remote control can be configured in:	
<div style="border: 1px solid black; padding: 5px;"> <p><input checked="" type="checkbox"/> Configuration, System</p> <p>LCD rotate view No</p> <p>Enable parameter set from network Yes</p> <p>Enable remote control Yes</p> <p style="text-align: center;"> ↶ ↑ </p> <p style="text-align: center;">Configuration of remote control</p> </div>	<p>To enable remote control of the panel it is necessary to allow remote control. This is done in the configuration of the system.</p>
<div style="border: 1px solid black; padding: 5px;"> <p><input checked="" type="checkbox"/> Status, Network</p> <p>IP address 10.165.178. 90</p> <p>Subnet mask 255.255.255. 0</p> <p>Default gateway 10.165.178. 1</p> <p>Power state network On</p> <p style="text-align: center;"> ↶ ↓ </p> <p style="text-align: center;">Identification of the IP-address</p> </div>	<p>IP-address of the CompactSmoke™</p>

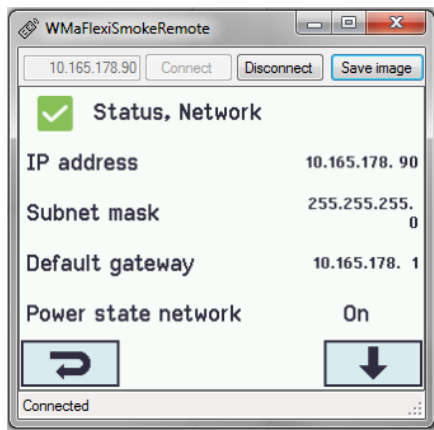

Screen shot from the PC when controlling the FlexiSmoke™ remotely

Start the 'WMaFlexiSmokeRemote program' on the connected PC. Enter the IP-address and press 'Connect'.

22 Commissioning and test run

In case of hardware error, please see chapter 19 "The menu 'Hardware error'"

The break glass unit WSK 50x will only give an acoustic fault signal if the door on the break glass unit is closed or if the door contact on the break glass unit is pressed.

We recommend that the software of the panel is updated during the annual maintenance check!

We recommend that the commissioning of the smoke panel should be done by a competent smoke ventilation controls installer.

22.1 The control ventilation panel is completely installed, without the operating voltage applied

- a) Check all mechanical and electrical components for damage.
- b) Check all screw and plug connections for tightness and/or firm seating.
- c) Check that all external components are installed:
 - 1) $\pm 24V$ actuators: Is the motor end module inserted in the last or only actuator?
 - 2) Automatic smoke detectors: Is the passive end module inserted in the last or only smoke detector?

22.2 With mains voltage, without accumulator

Adhere to the relevant regulations!

Connect the mains cables and reapply the mains voltage.

22.3 With mains voltage, with accumulator

- a) Connect the accumulators to the black accumulator bridge according to the wiring diagram, then connect the red and the black connection cable to the red and the black flat plug. Insert the batteries in the smoke ventilation panel according to chapter 13 "Back-up batteries".
- b) Plug the red connection cable to the + and the black connection to the flat plug of the control panel.
Note: Check correct polarity!
- c) The smoke ventilation panel can now be configured as described in chapter 15 "Configuration – main menu"

22.4 Ventilation keypad

Closely observe the actuators during opening and closing. They must not be impaired in any position by the building structure.

Observe that the actuator cables are not being subject to pulling or pinching.

Check each ventilation keypad individually.

22.5 Break glass unit WSK 50x

- a) Open the door and press the black Open button. The actuators move open through to the end position. The red alarm LED (also in the control panel) is ON; at the same time a permanent acoustic signal sounds (door contact on the break glass unit is pressed!).
- b) Press the Reset/Closed button in the break glass unit. The actuators close through to the end position. The comfort ventilation function is released again. The red alarm LED (also in the smoke ventilation panel) and the acoustic smoke alarm are turned off.

22.6 Smoke detectors

- a) Spray test aerosol on the smoke detectors (aerosol item no. 9549).
- b) The actuators move open through to the end position. The red LED in the smoke detector, the red alarm LED (also in the smoke ventilation panel) and the permanent acoustic signal in the break glass unit are ON.
- c) Press the Reset/Closed button in the break glass unit - the actuators close through to the end position. The comfort ventilation function is released again. The red alarm LED in the break glass unit and in the smoke control panel as well as the acoustic smoke alarm are turned off.

22.7 Emergency power supply test

- a) Disconnect the mains power. See also national guidelines.
- b) When a mains error have occurred the green LED in the break glass units will flash for 10 minutes. The green LED on the WCA 3SP card in the smoke ventilation panel is still on and the yellow LED is turned off.
- c) After 10 minutes the green LEDs will turn off and all the yellow LEDs in the smoke ventilation panel and the break glass units will lit continuously.
- d) Check that the comfort ventilation keypads are deactivated.
- e) Check that the break glass units are working (section 22.5)
- f) Connect the main power.
- g) The green mains and operating LED's are on, the yellow LED is off, the malfunction message at the break glass unit is off.

22.8 Wind/rain detector

- a) Open the actuators with the comfort ventilation keypads.
- b) Wet the rain sensor, the actuators will fully close.
- c) While the actuators are running, press the Open button at the keypad. The actuators must neither open nor stop! Exception: If set to a manual override time (Man. operation after auto comm.).
- d) Any smoke and heat extraction signal will always take priority over the wind/rain signal.
- e) While the rain sensor is active (wet) the smoke ventilation panel is activated (alarm) and the actuators move open through to the end position (alternatively to the SHE position)

If the start-up was successful, close the doors of the break glass units and of the smoke ventilation panel.

If the start-up was unsuccessful (error with one of the test run processes), please see chapter 10 "Description of cards". If necessary, check the wiring in accordance with the cable plan – see chapter 9 "Cable plan for connection to WSC 3xx".

23 Maintenance

The panels of the smoke and heat exhaust ventilation system have to be checked, serviced and, if necessary, repaired at least once per year by the manufacturer or an authorized partner.

Remove all soiling from the units of the smoke and heat exhaust system. Check fastening and clamping screws for firm seating. Carry out a test run of the entire system (see chapter 20 'Commissioning and test run). Only have defective units repaired in our factory. Only install original spare parts.

Check the operational condition at regular intervals. We recommend a WindowMaster service contract is taken out to ensure the right function of the smoke and heat exhaust system.

All back up batteries coming with the smoke control panel as standard; have to be subjected to regular checks.

The smoke ventilation panel will signal fault on the batteries if the battery voltage is below 17V.

Within the framework of the service, they have to be replaced after the specified **maximum 4** year operating period or if the voltage drops below 17V.

Dispose of used batteries according to the National regulation.

CAUTION: RISK OF EXPLOSION IF BATTERIES ARE REPLACED BY AN INCORRECT TYPE.

We recommend that the software of the panel is updated during the annual maintenance check!

The expected minimum lifetime for the CompactSmoke™ is 10 years excluding the batteries.

Caution: Disconnect Pyrotechnic gas generator cables prior to doing any maintenance work to prevent activation by mistake. Remember to connect the device again when maintenance is concluded.

23.1 Maintenance agreements

Be aware that regular inspection of smoke ventilation systems is a legal requirement. The legislation requires that the smoke ventilation system's owner inspects and tests the system once every year. WindowMaster offer maintenance agreements for the smoke ventilation system and every year we inspect the complete system to ensure it complies with the applicable legislation. Maintenance of the smoke ventilation system includes checking windows, window actuators and emergency power and checking that triggering and control functions are fully functional.

Contact our service department for further information: **telephone +44 1536 61 4070 or info@windowmaster.co.uk**

23.2 Replacement cards

23.2.1 Replacement of 3M8 and 3KI cards

1. Disconnect the 230 V and the batteries.
2. Wait until the display has completely turned off before removing the card.
3. Insert the replacement card.
4. Turn on the 230 V and connect the batteries.
5. The system will be ready again after approx. 2 seconds.

23.2.2 Replacement of 3SP card

1. Save a backup of the configuration on a USB stick (recommended).
2. Disconnect the 230 V and the batteries.
3. Wait until the display has completely turned off before removing the card.
4. Insert the 3PS replacement card.
5. Insert the USB stick into the new card.
6. Turn on the 230 V and connect the batteries.
7. Load the parameters from the USB stick
8. The system will be ready again after approx. 2 seconds.

If the WCA 3SP card, which is to be replaced, is completely without function then go straight to point 2.

If there is no backup of the configurations, these are to be entered manually.

It is therefore recommended to take a backup, on a USB stick, when the panel is running, if necessary, please see section 15.15.

24 Declaration of Conformity and Declaration of Performance

The smoke ventilation panels are manufactured and tested accordingly to the European requirements.

The total system is not to be put into service until a declaration of conformity for the total system has been made.

The "Declaration of Conformity" and the EN certificate are supplied with panel as separate documents.