

FlexiSmoke™

WSC 520 / 540 / 560

Installation instruction
From panel version E5

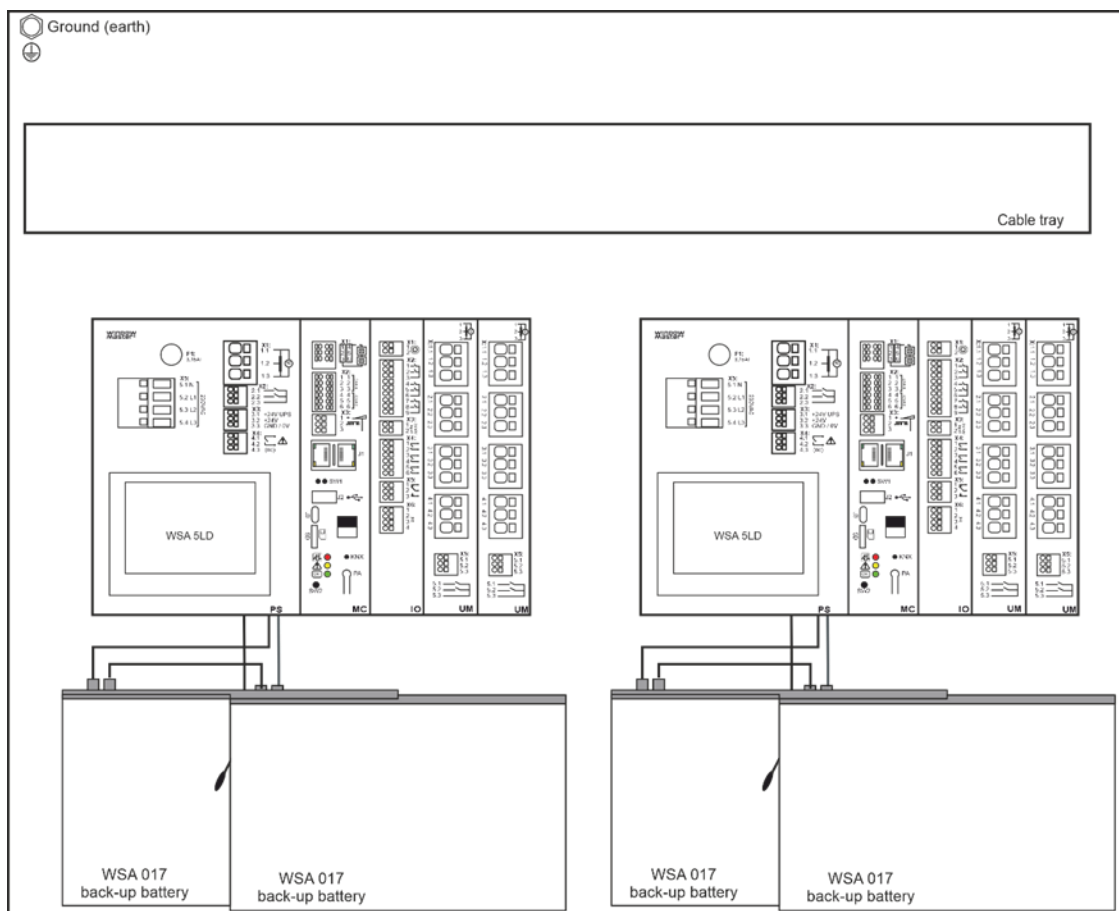

The drawing shows WSC 540 KIUU KIUU

For firmware version from:

Smoke panel version	
E5	2.02

The latest version of this document can always be found on our website
Save this installation instruction to the end user

Scan the QR-code and watch our
installation video showing how to
configure the FlexiSmoke™



UK +44 (0) 1536 0614 070 info.uk@windowmaster.com
IE +353 1903 9455 info.ie@windowmaster.com
Other markets +45 4567 0300 info.dk@windowmaster.com

www.windowmaster.com

Contents

1	Safety information	4
1.1	Safety	4
1.2	230V AC	4
1.3	Back-up batteries	4
1.4	Application	4
1.5	Cable routing and electrical connection	4
2	Structure of the smoke panel	5
2.1	Log in	6
2.1.1	PIN-codes and MAC addresses	7
2.1.2	Lost PIN-codes – resetting of panel	8
2.2	ISO 21927-9 related data	8
2.2.1	Access levels	9
3	Variants of panels	9
3.1	Number of motor lines, inputs and outputs depending on the combination of the three expansion modules	10
3.2	Examples with FlexiSmoke™	10
3.3	Max numbers of motors per motor line which can be connected per module	11
4	Modules, accessories, spare parts	12
5	Technical data	13
6	Mounting	15
7	Installation	15
7.1	Cable routing	15
7.2	Cables into housing	15
7.3	Connection of safety earth wire and 230V AC	15
7.4	Installation of the break glass unit, ventilation keypad and smoke detector	15
7.5	Assembly instructions	16
8	Cable dimensioning	16
8.1	Maintaining the cable functions	16
8.2	Formula for the calculation of the maximum motor cable length	16
8.3	Max. cable Length	17
8.3.1	Max cable length – ±24V standard motors	17
8.3.2	Max cable length – motors with MotorLink®	17
8.3.3	Max cable length – Pyrotechnic gas generator	18
9	Cable plan for connection to WSC 520 / WSC 540 / WSC 560	19
10	Description of modules	20
10.1	WSA 5PS power supply module 20A	20
10.2	WSA 5MC overall control module	23
10.3	WSA 5IO input/output module	28
10.4	WSA 5UM universal motor module	30
11	Cable monitoring of motors	32
11.1	Usage of non-WindowMaster motors	32
12	Back-up batteries	32
12.1	Measurement of battery charging voltage	33
13	Touch screen	33
13.1	Icons	33
13.2	Rotation of the touch screen	34
14	Configuration – main menu	34
14.1	Motor lines – motor groups – smoke zones	34
14.1.1	Examples with motor lines / motor groups / smoke zones	34
14.2	Motor line	34
14.2.1	Motor line - numbering	34
14.2.2	Motor line - configuration	35
14.2.3	Colour code - motor line	36
14.3	Motor group	36
14.3.1	Motor group - configuration	36
14.3.2	Colour code – motor group	36
14.4	Break glass unit	37
14.4.1	Break glass unit – configuration	37
14.4.2	Colour code – break glass unit	38
14.5	Smoke zone	38
14.6	Local input	39
14.6.1	Numbering of local inputs	39
14.6.2	Local input - configuration	39
14.6.3	Usage of wind/rain sensors - WLA 33x	41
14.7	Local output	42
14.7.1	Numbering of local output	42
14.7.2	Local output - configuration	42
14.8	Weather station type	43
14.9	Sequence control	44
14.10	Magnetic clamp (magnetic door retainer)	45
14.11	Pyrotechnic gas generator	46
14.12	Alarm output	47

14.13	CAN bus	48
14.14	Network	49
14.15	Fieldbus	49
14.15.1	KNX-bus	50
14.15.2	BACnet	50
14.16	Configuration files on SD	51
14.17	Configuration files on USB	52
14.18	System	52
14.18.1	Service timer	53
15	Status – main menu	54
16	Manual operation – main menu	54
17	Configuration missing – main menu	54
18	Hardware error – main menu	55
18.1	Error on the Power supply	55
18.1.1	Blown fuse – 20A fast	55
18.1.2	Blown fuse – 3.15A slow	56
19	Manage another WSA MC module – main menu	56
20	View all details – main menu	56
21	Remote control of FlexiSmoke™	56
22	Commissioning and test run	57
22.1	The control ventilation panel is completely installed, without the operating voltage applied	57
22.2	With mains voltage, without accumulator	57
22.3	With mains voltage, with accumulator	58
22.4	Ventilation keypad	58
22.5	Break glass unit WSK 50x	58
22.6	Smoke detectors	58
22.7	Emergency power supply test	58
22.8	Wind/rain detector	58
23	Maintenance	58
23.1	Maintenance agreements	59
23.2	Replacement modules	59
23.2.1	Replacement of 5PS, 5IO and 5UM modules	59
23.2.2	Replacement of 5MC module	59
24	Declaration of Conformity and CE certificate	59

1 Safety information

1.1 Safety

Only allow correspondingly trained, qualified and skilled personnel to carry out installation work.

Reliable operation and the avoidance of damage and hazards are only guaranteed if installation and settings are carried out carefully in accordance with these instructions.

There may be personal danger by electrically operated windows:

- the forces occurring in the automatic mode can be such that parts of the body could get crushed
- when opened, actuators (spindles) could protrude into the room

For this reason, measures have to be taken prior to starting up the actuators which exclude the danger of injury.

For safety reasons we recommend installing opening restrictors on bottom-hung windows.

In the event that windows are subjected to rain and/or high wind loads, we recommend connecting a wind/rain sensor to the smoke ventilation panel for the automatically closing of the windows.

The smoke ventilation panel is to be located in a safe place, protected from the effects of fire and smoke.

The smoke ventilation panel is to be surface mounted.

The smoke ventilation panel has two energy suppliers: 230V AC and back-up batteries.

The manufacturer does not assume any liability for possible damage resulting from inappropriate use.

1.2 230V AC

230VAC can cause death, severe injury or considerable damage to assets.

The connection of the smoke ventilation panel is reserved for qualified personnel.

Disconnect all poles of the panel from the supply voltage prior to opening, installation or assembling.

Installation and use according to the national regulations.

1.3 Back-up batteries

Back-up batteries 2 batteries per 20A-section (i.e. WSC 520 = 2 pcs, WSC 540 = 4 pcs and WSC 560 = 6 pcs.) can cause severe injury or considerable damage to assets.

The connection of the smoke ventilation panel is reserved for qualified personnel.

Disconnect all poles of the panel from the back-up batteries prior to installation or assembling.

Ensure that the mains cable can be switched via an external or customer-supplied two-pole switch element or a switch element controlling all poles – see section 7.1 “Cable routing”.

Installation and use according to the National regulations.

Dispose of used batteries according to the National regulation.

CAUTION - RISK OF EXPLOSION IF BATTERIES ARE REPLACED BY AN INCORRECT TYPE.

1.4 Application

The smoke ventilation panel is exclusively designed for the automatic opening and closing of smoke extraction systems, windows, flaps, or doors.

Always check that your system meets the valid national regulations.

Pay particular attention to the opening cross section, the opening time and opening speed.

The cable cross sections depend on the cable length and current consumption (amperage).

1.5 Cable routing and electrical connection

Fuse the 230V AC power supply cable separately on site.

Cable routing and connection - adhere to national regulations.

Establish the cable types, if necessary, with the local approval bodies or the fire protection authority.

Do not conceal flexible cables.

Junction box must be accessible for maintenance purposes.

Disconnect all poles of the mains voltage and the back-up batteries prior to starting maintenance work or making changes to the system.

Secure the system to prevent unintentional switching on again.

Route all low voltage cables (24V DC) separate from the power current cables.

Design cable types, lengths and cross sections in accordance with the technical information.

Cable specifications is a guide only, the overall responsibility resides with the electrical contractor on site.

Installation must be in accordance with the national electrical regulations.

2 Structure of the smoke panel

Sections

The FlexiSmoke™ smoke ventilation panel is available in three different sizes 20A, 40A and 60A. The smoke ventilation panel consists of 20A-sections, thus WSC 520 contains one section, WSC 540 two sections and WSC 560 three sections.

Modules

Each section contains the power supply module WSA 5PS, the overall control module WSA 5MC and 3 slots for expansion modules. The overall control module WSA 5MC is available with or without field bus interface for KNX or BACnet IP.

The expansion modules input/output module WSA 5IO or the universal motor module WSA 5UM, can be connected on the 3 expansion slots. Either $\pm 24V$ motors or motors with MotorLink® can be connected to the WSA 5UM module. The type and number of the expansion modules can be freely selected to suit the smoke panel required function.

Modules in the FlexiSmoke™ (example of a WSC 540)

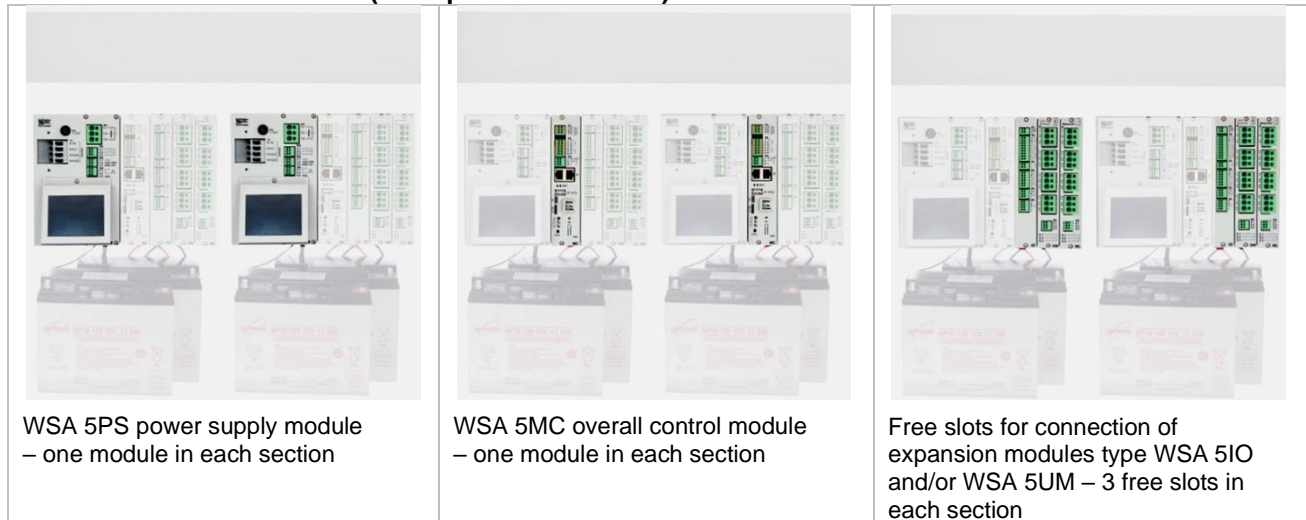

Selection of modules

Expansion modules are selected specifically for the task.

Example of module selection:

- 1 input/output module and no additional modules
- 1 input/output module and 1 universal motor module
- 3 universal motor modules

The expansion modules are to be mounted in the three slots 3, 4 and 5.

Panels ordered with WSA 5IO modules will always be delivered with these modules mounted before the WSA 5UM modules. In the field however, expansion modules can be mounted in an arbitrary order on the expansion slots.

Mounting of modules may only be done when there is no power on the panel (no battery or power on).

The item no. of the panel specifies the type and mounting of the expansion modules in the section/sections - see "Variants of panels" for more information

Motor groups and motor lines

A motor group consists of one or more motor lines and all motor connected on a motor line are operated simultaneously.

Each 20A section contains one 20A motor line for connection of $\pm 24V$ standard motors on the WSA 5PS module. If more motor lines are needed, one or more motor modules WSA 5UM are mounted. Each motor module contains four motor lines to which either $\pm 24V$ standard motors or MotorLink® motors can be connected.

A 20A-section contains therefore 1 ± 24 standard motor line and up to 12 motor lines for either ± 24 standard motors or MotorLink® motors. The total power consumption of all the motors must not exceed 20A.

Adding panels

The smoke ventilation system can be expanded by adding more FlexiSmoke™ panels, connected by CAN cable. For details see chapter 10.2.

Break glass unit

Break glass unit type WSK 50x are to be used together with FlexiSmoke™. The units are configured and assigned to smoke zones via the touch screen in the smoke ventilation panel.

Smoke zones

Up to 13 independent smoke zones per 20A section can be implemented by the panel.

Inputs

All inputs and outputs on the FlexiSmoke™ smoke ventilation panel can be freely configured – this means that they can be assigned to functions across modules and 20A-sections.

Cabling

FlexiSmoke™ uses bus technology and the overall cabling for break glass units, smoke detectors and keypads is significantly reduced compared to other types of smoke panels:

- the break glass units are series connected, therefore is not necessary to cable from each break glass unit to the smoke ventilation panel
- keypads for ventilation and smoke detectors are connected directly to the break glass units type WSK 501/502 in the smoke zones

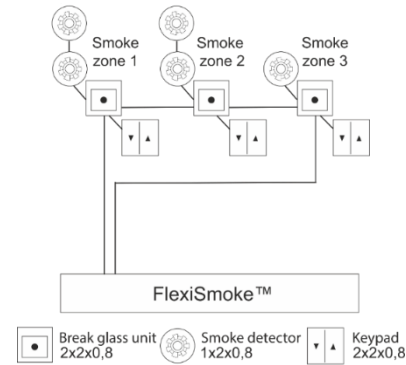

System example with WSC 540

Smoke ventilation panel with two sections (2 x 20A) configured in five smoke zones. Total motor power consumption in the first section is 20A (smoke zone 1- 2 - 3) and the total motor power consumption in the second section is 3A (smoke zone 4 - 5).

The keypads and break glass units are cabled directly to the break glass units type WSK 501/502 in the smoke zones which mean that the need for cabling in the building is significantly reduced.

A wind/rain sensor is connected to close the windows during comfort ventilation in case of high wind and/or rain.

The smoke ventilation panel is connected to the Fire Alarm System via the WSA 5IO module.

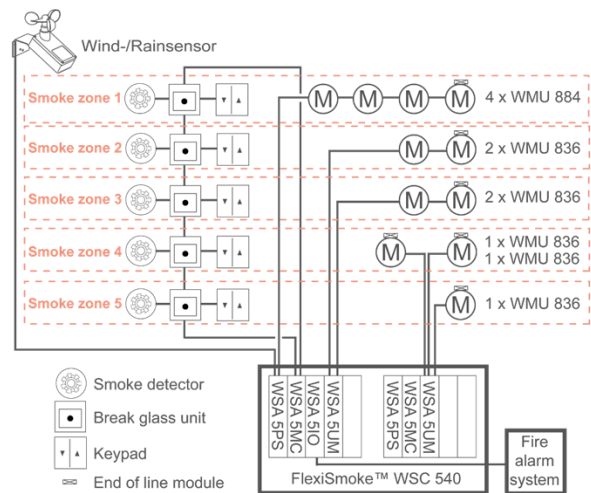

2.1 Log in

The access level to the smoke ventilation panel is set in five levels.

Level	Access to	Who has access
1	Public You can see the smoke ventilation panel from the outside with the door closed and locked	Everyone
2	Operation You can open the panel house and operate the touch screen for showing the status and manual operating of the windows. All the menus on the touch screen can be viewed but no values can be changed.	Chosen persons with a special key
3	Resetting service timer	Chosen persons with special key and having pin code for access level 3. Pin code is created during commissioning. Creating a PIN-code for access level 3 requires access level 4.
4	Configuration You can open the panel house and operate the touch screen for showing status, manual operating of the windows as well as configuration and changing the pre-set values. All the menus and sub menus can be seen, and the values can be changed. Access Level 4 is locked with a PIN code, so there is only access to the level when the PIN is entered.	Chosen persons with a special key and having the PIN code for access to level 4. Each section in a FlexiSmoke panel is given an individual level 4 PIN code during production, see chapter PIN-codes and MAC addresses below.
5	Maintenance Administrative overall level: for operating as on access level 4 as well as updating with new software. Access Level 5 is locked with a factory set PIN.	Only available for WindowMaster. The function is locked with PIN code.

2.1.1 PIN-codes and MAC addresses

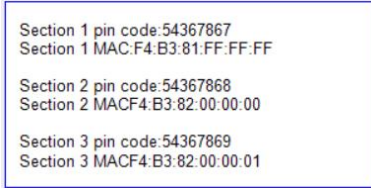

Each section in the FlexiSmoke panel has its own 8-digit access level 4 PIN-code as well as individual MAC-addresses. The default individual level 4 PIN-code(s), a panel receives in production are shown on a label inside the panel together with the panel's MAC address(es).

Label with production PIN-codes for access level 4 and MAC addresses for a WSC 560 panel.

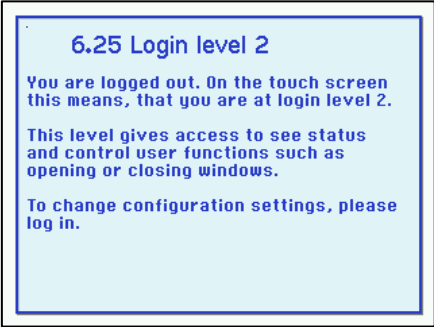

When starting the commissioning of a panel for the first time, the production individual PIN code must be used to logon and gain access to its configuration.

We recommend that the production PIN code of the panel is changed to a new code to ensure that unauthorised persons will not be able to access and change configuration of the panel either locally or remotely through WMaFlexiSmokeRemote. The new individual PIN code(s) must be 8 digits long. The code should be noted and kept in a safe place, to ensure that panels can be accessed again when needed.

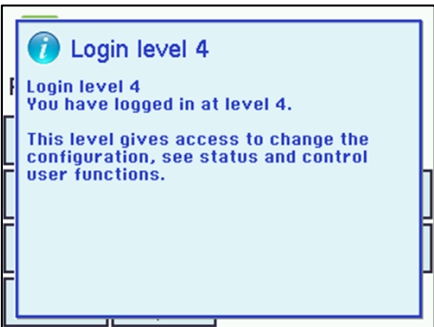
 <p>The user is on access level 2</p>	<p>The user is at access level 2.</p> <p>To open for access to other levels, enter the PIN for access the level.</p>
 <p>Enter PIN code</p>	<p>Enter PIN code for e.g. level 4.</p>
 <p>Access approved to login level 4</p>	<p>The user is at access level 4.</p> <p>With access to level 4 it is possible to:</p> <ul style="list-style-type: none"> - Set a PIN code for level 3. Creating a PIN-code for level 3 is optional. - Change the PIN code for level 4.

Login shall be configured in:

Configuration of login



<input checked="" type="checkbox"/>	View all details, Login
PIN 3: Service timer	<Min. 8 digits>
PIN 4: configuration	43214321
PIN 4: Production value	43214321
Log out time-out	600 s
	

The access levels can be locked and access to the level is only possible with a PIN code.

Each level has a unique PIN code.

1. PIN 3: Service timer. The yellow "error icon" will disappear when a code has been entered. If a code is not created the yellow "error icon" will remain.
2. PIN 4: Configuration. New PIN-code created during e.g. commissioning. If the code is not changed a yellow "error icon" will remain.
3. PIN 4: Production value. Default PIN-code set during production. This code is also printed on the label.
4. Log out time-out (the period of access to the level before the system automatically lock the level)

The appendix contains all the items that can be configured - see appendix for detailed explanation.

It is possible to lock the touch screen before the time has expired: press  followed by pressing 

2.1.2 Lost PIN-codes – resetting of panel

If the new PIN codes are lost, the panel's configuration can be reset to 'Factory default' by pressing and holding down button "SW2" and then pressing the "Reset" button.

The "SW2" button must be kept down for 6 seconds after the "Reset" button has been released.

The level 4 individual PIN code will be reset to the production code, printed on the label.

If the PIN-code label has been damaged / removed the level 4 PIN-codes can be retrieved by WindowMaster.

Note all the panel's parameters will be changed to their 'Factory default' values and the panel will have to be reconfigured from scratch. We recommend therefor to save the configuration backup file of a panel so reconfiguring the panel after a 'Factory default' reset will be easy.

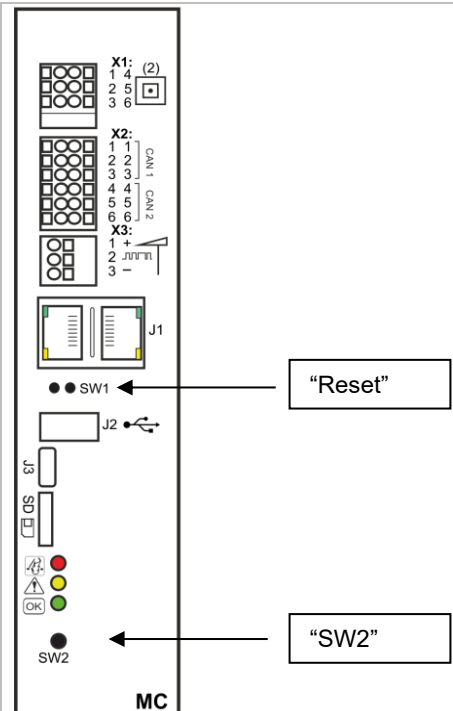

2.2 ISO 21927-9 related data

Panel version E5 is approved and certified according to ISO 21927-9.

The following optional indications, as defined in ISO 21927-9 clause 5 are included.

- Audible indication
- Output to fire alarm
- Output to systems other than actuators
- Deadlock (type A) (reopening of windows every 2nd min for 30min)
- Co-incidence detection
- Dependency on more than one alarm signal
- Output of the fault conditions

The panel is an ISO 21927-9 Type D panel.

Minimum 1 break glass unit type WSK 5xx must be installed together with the panel, for the panel to conform with the ISO 21927-9 standard.

2.2.1 Access levels

Level	Access to	Who has access
1	Public You can see the smoke ventilation panel and break glass unit from the outside with the doors closed and locked	Everyone / General public
2	Operation You can open the break glass unit and reset the system	Chosen person e.g., building facility manger with a special key to break glass unit.
3	Configuration You can open the panel house and operate the touch screen for showing status, manual operating of the windows as well as configuration and changing the pre-set values. All the menus and sub menus can be seen, and the values can be changed. ISO access level 3 is protected by the panel's level 4 PIN code, so there is only access to the level when the level 4 PIN is entered.	Chosen persons with a special key and having the panel level 4 PIN code can access to ISO level 3 / authorized to re-configure and service the panel e.g., a trained technician. PIN code(s) can be found on the label in the panel door.
4	Maintenance Administrative overall level: for operating as on ISO access level 4 as well as updating with new software. ISO level 4 is protected by the panel's level 5 PIN cod, so there is only access to the level when the level 5 PIN is entered.	A trained technician, with access to the key to the panel, authorized by WindowMaster to upgrade the firmware of the panel and with a computer running the upgrading application, supplied by WindowMaster.

3 Variants of panels

Item composing						
Size of the smoke ventilation panel	WSC 5??	?	?	?	?	Ex
20A = WSC 520, 40A = WSC 540, 60A = WSC 560	WSC 5??					
Selection of modules The four modules listed below must be defined for each 20A section - WSC 520 has one section, WSC 540 has two sections and WSC 560 has three sections.						
Select module: Overall control module						
WSA 5MC NCO – without field bus interface		0				
WSA 5MC KNX – with field bus interface for KNX/BACnet IP		K				
Select modules: Expansion modules						
First expansion module (slot 3, the first free slot in the section)						
No module		0				
WSA 5IO – input-/output-module *		I				
WSA 5UM – universal motor module for ±24V standard motors or MotorLink® motors		U				
Second expansion module (slot 4, the second free slot in the section)						
No module			0			
WSA 5IO – input-/output-module *			I			
WSA 5UM – universal motor module for ±24V standard motors or motors with MotorLink®			U			
Third expansion module (slot 5, the third free slot in the section)						
No module				0		
WSA 5IO – input-/output-module *				I		
WSA 5UM – universal motor module for ±24V standard motors or motors with MotorLink®				U		
Certification / Product version number						
E = EN 12101-10, ISO 21927-9						E
x = product version number						X**

* Module position, the IO module is mounted in slot 3 and if further IO modules are added, the IO module is mounted before the motor module.

** only panel versions from 5 contains the universal motor module WSA 5UM

3.1 Number of motor lines, inputs and outputs depending on the combination of the three expansion modules

The table shows the number of motor lines and inputs obtained per 20A section depending on the combination of the expansion modules.

Combination of expansion modules	Number				
	Motor lines ±24V standard	Motor lines Universal (±24V standard or MotorLink®)	Inputs x 2	Outputs (solid state)	Outputs (relay) (nc+no)
000	1	0	1	1	0
I00	1	0	4	4	1
II0	1	0	7	7	2
III	1	0	10	10	3
IU0	1	4	5	4	1
IUU	1	8	6	4	1
IIU	1	4	8	7	2
U00	1	4	2	1	0
UU0	1	8	3	1	0
UUU	1	12	4	1	0

3.2 Examples with FlexiSmoke™

Number/type of motor groups and other functions	Expansion modules	Item number
Examples with WSC 520		
1 ±24V standard motor line	no communication no expansion modules	WSC 520 0000 Ex
1 ±24V standard motor lines and 4 universal motor lines	1 x WSA 5UM universal motor module	WSC 520 0U00 Ex
1 ±24V standard motor lines, 4 universal motor lines and KNX/BACnet IP field bus interface	1 x WSA 5MC overall control module with KNX/BACnet IP 1 x WSA 5UM universal motor module	WSC 520 KU00 Ex
1 ±24V standard motor lines, 4 universal motor lines, KNX/BACnet IP field bus interface and input / output module	1 x WSA 5MC overall control module with KNX/BACnet IP 1 x WSA 5IO input/output module, 1 x WSA 5UM universal motor module	WSC 520 KIU0 Ex
1 ±24V standard motor lines, 8 universal motor lines, KNX/BACnet IP field bus interface and input / output module	1 x WSA 5MC overall control module with KNX/BACnet IP 1 x WSA 5IO input/output module 2 x WSA 5UM universal motor module	WSC 520 KIUU Ex
1 ±24V standard motor lines, 8 universal motor lines and KNX/BACnet IP field bus interface	1 x WSA 5MC overall control module with KNX/BACnet IP 2 x WSA 5UM universal motor module	WSC 520 KUU0 Ex
1 ±24V standard motor lines, 12 universal motor lines and KNX/BACnet IP field bus interface	1 x WSA 5MC overall control module with KNX/BACnet IP 3 x WSA 5UM universal motor module	WSC 520 KUUU Ex
Example with WSC 540		
2 ±24V standard motor lines and 16 universal motor lines	2 x WSA 5IO input/output module 4 x WSA 5UM universal motor module	WSC 540 0IUU 0IUU Ex
Example with WSC 560		
3 ±24V standard motor lines, 20 universal motor lines and KNX/BACnet IP field bus interface	3 x WSA 5MC overall control module with KNX/BACnet IP 5 x WSA 5UM universal motor module	WSC 560 KU00 KUU0 KUU0 Ex

3.3 Max numbers of motors per motor line which can be connected per module

The table shows the maximum number of motors that can be connected per motor line on one module depending on the type of the module. The total power consumption of all the connected motors must not exceed 20A per section.

Type of motor	Max. total 20A per section				
	WSA 5PS-module 1 x 20A-motor line $\pm 24V$	WSA 5UM-module 4 x 10A-motor lines			
		$\pm 24V$ motors per motor line	$\pm 24V$ motors per module	MotorLink® motors per motor line	MotorLink® motors per module
WMS 409 xxxx 01	10	5	10	0	0
WMS 409-1	10	5	10	4	10
WMS 409-2	10	4	10	2	8
WMS 409-3	9	3	9	3	9
WMS 409-4	8	4	8	4	8
WMS 515	4	2	4	0	0
WMU 831 / 851-1	20	10	20	4	16
WMU 831 / 851-2	20	10	20	2	8
WMU 831 / 851-3	18	9	18	3	12
WMU 831 / 851-4	20	8	20	4	16
WMU 836-1	20	10	20	4	16
WMU 836-2	20	10	20	2	8
WMU 836-3	18	9	18	3	12
WMU 836-4	20	8	20	4	16
WMU 852-1	9	4	9	4	9
WMU 852-2	8	4	8	2	8
WMU 852-3	9	3	9	3	9
WMU 852-4	8	4	8	4	8
WMU 861-1	13	6	13	4	13
WMU 861-2	12	6	12	2	8
WMU 861-3	12	6	12	3	12
WMU 861-4	12	4	12	4	12
WMU 862 / 882-1	9	4	9	4	9
WMU 862 / 882-2	8	4	8	2	8
WMU 862 / 882-3	9	3	9	3	9
WMU 862 / 882-4	8	4	8	4	8
WMU 863 / 883-1	6	2	6	2	6
WMU 863 / 883-2	6	2	6	2	6
WMU 863 / 883-3	6	3	6	3	6
WMU 863 / 883-4	4	0	0	0	0
WMU 864 / 884-1	4	2	4	2	4
WMU 864 / 884-2	4	2	4	2	4
WMU 864 / 884-3	3	0	0	0	0
WMU 864 / 884-4	4	0	0	0	0
WMU 885-1	4	2	4	2	4
WMU 885-2	4	2	4	2	4
WMU 885-3	3	0	0	0	0
WMU 885-4	4	0	0	0	0

Type of motor	Max. total 20A per section				
	WSA 5PS-module 1 x 20A-motor line $\pm 24V$	WSA 5UM-module 4 x 10A-motor lines			
		$\pm 24V$ motors per motor line	$\pm 24V$ motors per module	MotorLink® motors per motor line	MotorLink® motors per module
WMU 895-1	4	2	4	2	4
WMU 895-2	4	2	4	2	4
WMU 895-3	3	0	0	0	0
WMU 895-4	4	0	0	0	0
WMX 503 / 504 / 523 / 526-1	40	20	40	4	16
WMX 503 / 504 / 523 / 526-2	40	20	40	2	8
WMX 503 / 504 / 523 / 526-3	39	18	39	3	12
WMX 503 / 504 / 523 / 526-4	40	20	40	4	16
WMX 803 / 804 / 813 / 814 / 823 / 826-1	20	10	20	4	16
WMX 803 / 804 / 813 / 814 / 823 / 826-2	20	10	20	2	8
WMX 803 / 804 / 813 / 814 / 823 / 826-3	18	9	18	3	12
WMX 803 / 804 / 813 / 814 / 823 / 826-4	20	8	20	4	16
WMD-1	20	10	20	4	16
WMD-2	20	10	20	2	8
WMD-3	18	9	18	3	12
WMD-4	20	8	20	4	16
WML 820/825	20	10	20	0	0
WML 860	20	10	20	4	16
WMB 801/802*	max. 4A connected to the WMB	max. 4A connected to the WMB		0	0
WMB 811/812 */**	20	10	20	2	8
WMB 01M*/**	0	0	0	2	8

* Do not exceed the total power consumption of the motor line
** When having two locking motors per motor line, it must be one of each type: 1 x WMB 811 and 1 x WMB 812
*** The service input on the WMB 01M is ignored and can therefore not be used. When having two locking motors per motor line, it must be one of each type: 1 x WMB 01M and 1 x WMB 02M.

4 Modules, accessories, spare parts

Modules	
Power supply module 20A with 1 pcs. end of line module WSA 510	WSA 5PS
Overall control module without field bus interface	WSA 5MC NCO
Overall control module with field bus interface for KNX/BACnet-IP	WSA 5MC KNX
Input/output module	WSA 5IO
Universal motor module for $\pm 24V$ standard motors with 4 pcs. end of line module WSA 510	WSA 5UM
Accessories	
Back-up battery 18Ah (2 x WSA 017 per 20A-section)	WSA 017
FlexiSmoke™ break glass unit, primary, with data communication, plastic housing. Optional connection to ventilation keypad and smoke detector (only 1 per line). (x=colour of the housing: 1=red, 2=yellow, 3=grey, 5=orange)	WSK 501 000x
FlexiSmoke™ break glass unit, primary, with data communication, metal housing. Optional connection to ventilation keypad and smoke detector (only 1 per line). (x=colour of the housing: 2=yellow, 3=grey, 5=orange)	WSK 502 000x
FlexiSmoke™ break glass unit, primary, with data communication, plastic housing. Not possible to connect ventilation keypad and smoke detector. (x=colour of the housing: 1=red, 2=yellow, 3=grey, 5=orange)	WSK 503 000x
FlexiSmoke™ break glass unit, primary, with data communication, metal housing. Not possible to connect ventilation keypad and smoke detector. (x=colour of the housing: 2=yellow, 3=grey, 5=orange)	WSK 504 000x

Fireman override switch	WSK 510
Smoke detector	WSA 311
Rain sensor	WLA 331
Rain/wind sensor	WLA 330
Rain/wind sensor, with pulse output	WLA 340
Weather station (only panel version E2 and E4)	WOW 600
End of line motor module, 10 pcs.	WSA 510
10kΩ resistance, 10 pcs.	WSA 501
Fire alarm system module	WSA 306
Cable for CAN connection, 2x2x0,5mm ² , sold in hole meters	WLL 501
Cable for wind and rain sensor WLA 340, 4m UV-resistant cable 4 x 2 x 0,75mm ²	WLL 604
Cables for comfort ventilation – see separate data sheet for further information	WLL 7xx
Cables for smoke ventilation – see separate data sheet for further information	WLL 8xx
Cable glands for smoke panels	WSA 333
USB stick for log-data, back-up and firmware updates	WCA 304
Comfort keypad for 1 window or 1 window group	WSK 110 0A0B
Comfort keypad for 2 windows or 2 window groups	WSK 120 0A0B 0A0B
Spare parts	
Touch screen for WSA 5PS module	WSA 5LD
Back plane for modules, with top and bottom plate	WSA 5BP
Micro SD card for FlexiSmoke™, special industrial grade	WSA 502
Safety lock incl. 2 keys for smoke ventilation panel housing	WSA 438
Spare key for smoke panel, 1 pcs.	WSA 439
Plugs: 2 pcs. 6-pin plugs for CAN bus and 2 pcs. 3-pin plugs for break glass units	WSA 540
Replacement glass for break glass units type WSK 501, 5 pcs.	WSK 397
Keys for break glass units type 501 / 503, 5 pcs.	WSK 398
Keys for break glass units type 502 / 504, 1 pcs.	WSK 453
Lockable replacement plastic housing for break glass unit x=colour of the housing: 1 = red, 2 = yellow, 3 = grey, 5 = orange	WSK 399 000x

5 Technical data

Technical data							
Output current (nominal)	WSC 520: 20A / WSC 540: 40A / WSC 560: 60A						
Actuator secondary voltage	<table style="width: 100%; border: none;"> <tr> <td style="width: 60%;">Motor voltage</td> <td>24V DC (±15%)</td> </tr> <tr> <td>Open circuit voltage at 230V AC (no load)</td> <td>27.6V DC @ 20°</td> </tr> <tr> <td>Ripple at max load</td> <td>max. 6% (3.5Vpp)</td> </tr> </table>	Motor voltage	24V DC (±15%)	Open circuit voltage at 230V AC (no load)	27.6V DC @ 20°	Ripple at max load	max. 6% (3.5Vpp)
Motor voltage	24V DC (±15%)						
Open circuit voltage at 230V AC (no load)	27.6V DC @ 20°						
Ripple at max load	max. 6% (3.5Vpp)						
Motor lines Motor groups Smoke zones	<p><u>Per 20A section</u> max. 13 motor lines (1 x 20A ±24V standard motor line and 12 x ±24V standard / MotorLink® motor lines) in max 13 motor groups and max 13 smoke zones</p> <p>Via the software more motor lines can be connected in the same group</p>						
Primary voltage	<p>WSC 520: 1 x 230V AC (±10%) / 50Hz WSC 540: 2 x 230V AC (±10%) / 50Hz WSC 560: 3 x 230V AC (±10%) (400V AC) / 50Hz</p>						

Power consumption	<p>WSC 520: min 2.5W¹⁺², typ. 2.8W¹⁺³. At max load 540W WSC 540: min 5.0W¹⁺², typ. 5.6W¹⁺³. At max load 1080W WSC 560: min 7.5W¹⁺², typ. 8.4W¹⁺³. At max load 1620W</p> <p>1) no load: system operational but no motors are running 2) min: with 1 x break glass unit WSK 501/502 + 1 x smoke detector WSA 311 per 20A section 3) max load: with 4 x break glass unit WSK 501/502 + 4 x smoke detector WSA 311 per 20A section</p>	
Leakage current	<p>WSC 520: Max 0.4mA @ 240VAC WSC 540: Max 0.8mA @ 240VAC WSC 560: Max 1.2mA @ 240VAC</p>	
Inrush current on primary site	<p>WSC 520: 30A<0.05ms WSC 540: 60A<0.05ms*), WSC 560: 90A<0.05ms*) [*]= 30A < 0.05ms on each phase]</p>	
±24V change over time	min 500ms	
Back-up batteries (to be ordered separately)	<p>WSC 520: 2 x WSA 017 (12V/17-18Ah) WSC 540: 4 x WSA 017 WSC 560: 6 x WSA 017</p> <p>Expected lifetime max 4 years, only use genuine WindowMaster batteries</p>	
Emergency power	>72 hours in accordance with EN 12101-10	
Charging unit (integrated in WSA 5PS module)	<p>Charging voltage: 27.7 – 27.8 at 20°C Charging current: 3A, current limited</p>	
Priority	Smoke signal has always highest priority	
Cable monitoring	<p>±24V standard motors with end of line module and smoke detectors are monitored by closed-circuit</p> <p>Motors with MotorLink® and break glass units are monitored by data communication</p> <p>Back-up batteries are monitored by cyclic measuring</p>	
LED message OK, fault and alarm	<p>Green Yellow Red</p>	<p>all OK fault fire</p>
Reopening the actuators	Every 2.min. in 30min. after a SHE open (selectable) Preset: <u>no</u> reopening	
Connection cable	<p>Motors Other components</p>	<p>flexible max 6 mm² / solid max 10 mm² min 0.2mm² / max 1.5mm², flexible stranded cores are only suitable with attached ferrules</p>
Operating conditions	<p>-5°C - +40°C, max. 95% relative humidity (not condensing) EN 12101-10: Operation class A, Environmental class 1, with IP value increased to IP 54</p>	
Switch-on duration	ED 40% (4min. per 10min.)	
Max allowed current drawn from the battery when the primary power source is disconnected	20.2A	
Max interruption time during switching between power sources	2.0sec	
Break glass unit	<p>Up to 30 break glass units type WSK 50x can be connected to the WSA 5MC module per 20A section. Up to 10 smoke detectors can be connected on 10 of these units type WSK 501/502, which give a maximum of 100 smoke detectors.</p> <p>Ventilation keypads can also be connected to all the break glass units type WSK 501/502 – there is no limit on the number of keypads.</p> <p>Smoke detectors and ventilation keypads cannot be connected to the break glass units type WSK 503/504.</p>	
Number of motor lines per module	<p>WSA 5PS WSA 5UM</p>	<p>1x 20A motor line for ±24V standard motors 4 x 10A motor lines for either ±24V standard motors or MotorLink® motors</p> <p>Note: A total of max 20A current consumption on each 20A section of the smoke ventilation panel</p>
Material	Metal housing for surface mounting	

Colour	Grey (RAL 7035)
Size	WSC 520: 400 x 600 x 210mm (WxHxD) WSC 540: 600 x 600 x 210mm WSC 560: 1000 x 800 x 210mm
Weight	WSC 520: 16.5kg no batteries, 28.5kg with batteries (2 x WSA 017) WSC 540: 24.5kg no batteries, 48.5kg with batteries (4 x WSA 017) WSC 560: 54kg no batteries, 90kg with batteries (6 x WSA 017)
Protection class	IP54
Approval / certification	Approved and certified according to EN 12101-10 and ISO 21927-9
Delivery	FlexiSmoke™ smoke ventilation panel with WSA 501 (10kΩ resistors, 10 pcs.); WSC 520 x1, WSC 540 x2, WSC 560 x3 and 1 pcs. end of line module WSA 510 Back-up batteries to be ordered separately.
To be ordered separately	Back-up battery WSA 017 (12V/17-18Ah) - order 2 batteries per 20A section
Note	We reserve the right to make technical changes

6 Mounting

The smoke ventilation panel is fixed to the wall through the Ø9mm holes in the back plane of the housing.

If the panel is fixed in different way, the holes are to be blinded with the 4 blind grommets, this way the IP class is maintained.

The door is turnable.

When turning the door also move the blind grommets to the new holes.

The smoke ventilation panel is to be located in a safe place, protected from the effects of fire and smoke.

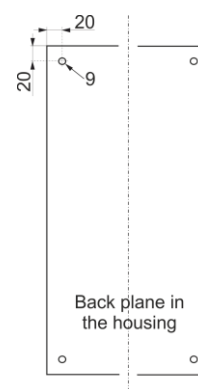

7 Installation

7.1 Cable routing

For cable routing we recommend the use of fire protected cables retaining their function E90 or E30.

See also chapter 8 “Cable dimensioning” in this instruction.

However, this has to be agreed with the Engineer or, if necessary, with the local fire protection department.

Do not reduce the cable cross sections specified in the cable lengths table. All cables of the control (except the mains supply cable) carry 24V DC and have to be routed separate from the mains supply cable.

Adhere to the pertinent national and local regulations when routing the cables. Lead the connection cables into the housing of the control panel from above and the cable glands shall comply with fire class V-1 (IEC/EN 60695-11-20 / UL 94) or higher.

Ensure that the mains cable can be switched via an external or customer-supplied two-pole switch element or a switch element controlling all poles – see drawing.

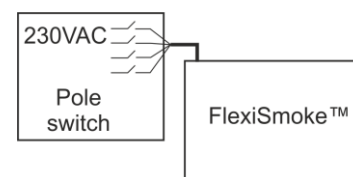

7.2 Cables into housing

All connection terminals (except the mains terminals) are of the plug-in type.

Connect the connection cables in accordance with the terminal plan. Ensure that the connections are made correctly.

Incorrect cable clamping, mixing up numbers or colours could lead to malfunctions of the control panel or of the external components. Ensure that the electrical cables are always routed according to the valid national and local regulations.

7.3 Connection of safety earth wire and 230V AC

See chapter 10 ‘Description of modules’, section 10.1, point X5 for further description.

7.4 Installation of the break glass unit, ventilation keypad and smoke detector

Ensure that the break glass unit and the ventilation buttons are visible and well accessible.

Do not install behind protruding walls, door panels or hidden by the building structure.

Note: Installation height of the break glass unit 1.5 – 1,7m above floor.

Install the smoke detectors in accordance with their enclosed instructions.

7.5 Assembly instructions

Always have assembly, installation, repair and maintenance of smoke and heat extraction systems carried out by qualified personnel trained for this purpose.

Rules to be adhered to for setting up and installation.

The following safety relevant rules must be adhered to when planning the use of a smoke and heat extraction system and its set-up and installation:

- The Provincial Building Ordinance of the provinces,
- The regulations of the competent fire protection authority,

Accident prevention regulations

Adhere to the general accident prevention regulations (APR), the APR for power operated windows and doors, and the installation rules in your country.

CAUTION:

Live components are directly accessible after opening the system housing.

Prior to inserting / removing modules disconnect to the panel from the mains supply and the back-up batteries.

- adhere to the installation instructions and your local energy providers
- select the place of installation such that free access is guaranteed for maintenance purposes
- select cables according to regulations in this instruction - take the calculation of the motor supply cable lengths into account when laying the cables
- power cables entered via the cable glands
- connect the cables in accordance with the drawings provided by the manufacturer
- route the cables in the building according to the regulations in this instruction
- after the smoke panel is installed the back-up batteries will be fully charged after ca. 8 hours
- check all system functions

Electric cable routing for smoke and heat extraction systems

Electrical cables always have to be laid in accordance with the national and local rules in your country.

Do not use the PE wire / green/yellow wire!

Cables of type NYM, concealed, can be used.

For surface laying, halogen free safety cables are recommended (see cable plan).

If possible, the use of cable types should be agreed with the Technical Services and the competent fire protection authority.

For the maximum permissible cable lengths of the motor supply cables for the WSC 5XX system, taking the specified cable cross sections into account (cable information for surface laying), please refer to chapter 8 "Cable dimensioning".

8 Cable dimensioning

8.1 Maintaining the cable functions

According to valid national regulations.

The cable network for smoke ventilation systems ("Cable system") ends normally at the interface (junction box) for the actuator!

The flexible, heat resistant connection cable of actuator is part of the system component, electric motor actuation' and is not a part of the electrical installation!

We recommend in all cases to discuss the type of cable routing with the competent fire fighting authorities.

8.2 Formula for the calculation of the maximum motor cable length

Max. cable length = $\frac{\text{permissible voltage drop } 2V \text{ (UL)} \times \text{conductivity of copper(56)} \times \text{cable cross section in mm}^2 \text{ (a)}}{\text{max. motor current total in amps (I)} \times 2}$

Example

Max motor cable length with cable cross section 0.75mm^2 and actuator current 2A: $(2 \times 56 \times 0.75) : (2 \times 2) = \underline{21\text{m}}$

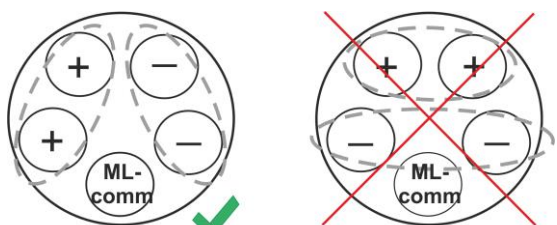
<p>Maximum motor cable length Always routed from the central smoke control unit to the last junction box</p> <p>Permissible max. voltage drop in the line 2 Volt</p> <p>Actuating current: Sum of all motor power consumption per motor line</p> <p>The motor supply cable must have 3 wires: 2 wires current carrying /1 wire for monitoring.</p> <p>Note: do not use the PE wire / green/yellow wire!</p>	<p style="text-align: center;">When 5 wire cable and MotorLink®</p> <div style="text-align: center;">  </div> <p style="text-align: center;">ML-comm = MotorLink® communication. It is not recommended to use parallel-wire.</p>
---	---

Furthermore, when using a 5-core cable, the distance between "-" and "Com" must be the same as the distance between "+" and "Com".

Meaning if L2 e.g. is being used as "Com" L1 and L3 must be used for "+" and "-".

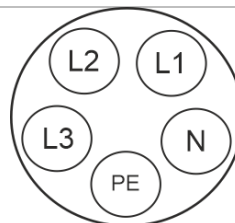

8.3 Max. cable Length

Maximum permissible cable length from the smoke ventilation panel to the motors and pyrotechnic gas generator taking into account the cable cross-section is shown in the following tables for "± 24V standard motors", "MotorLink® motors" and pyrotechnic gas generator.

Before selecting the cable type, please see X1-X4 in section WSA 5UM universal motor module.

8.3.1 Max cable length – ±24V standard motors

±24V standard motors						
Do not use the PE wire / green/yellow wire!						
cable cross section [a]	3 wire * 0.75mm²	3 wire * 1.50 mm²	5 wire * 1.50 mm² 2 wire parallel	3 wire * 2.50 mm²	5 wire * 2.50 mm² 2 wire parallel	3 wire 4.00 mm²
Total actuator current [I]						
1A	42m	84m	168m	140m	280m	224m
2A	21m	42m	84m	70m	140m	112m
3A	14m	28m	56m	47m	93m	75m
4A	11m	21m	42m	35m	70m	56m
5A	8m	17m	34m	28m	56m	45m
6A	7m	14m	28m	23m	47m	37m
7A	6m	12m	24m	20m	40m	32m
8A	5m	11m	21m	18m	35m	28m
9A		9m	18m	15m	31m	25m
10A		8m	16m	14m	28m	22m
20A		4m	8m	7m	14m	11m

8.3.2 Max cable length – motors with MotorLink®

When using actuators with MotorLink® the max/total cable length is 50m regardless of the result of the above mentioned formula.

Motors with MotorLink®						
Do not use the PE wire / green/yellow wire!						
cable cross section [a]	3 wire * 0.75mm²	3 wire * 1.50 mm²	5 wire * 1.50 mm² 2 wire parallel	3 wire * 2.50 mm²	5 wire * 2.50 mm² 2 wire parallel	3 wire * 4.00 mm²
Total actuator current [I]						
1A	42m					50m
2A	21m	40m				50m
3A	14m	28m	50m	47m		50m
4A	11m	21m	42m	35m		
5A	8m	17m	34m	28m	50m	45m
6A	7m	14m	28m	23m	47m	37m
7A	6m	12m	24m	20m	40m	32m
8A	5m	11m	21m	18m	35m	28m
9A		9m	18m	15m	31m	25m
10A		8m	16m	14m	28m	22m
20A		4m	8m	7m	14m	11m

Definition of total cable length

The total cable length is defined as the sum of all cables from the MotorController output to the last actuator. Including the cable mounted on the actuator.

For example, in case of 4 actuators with 5m cable each, the remaining cable length is 30m.

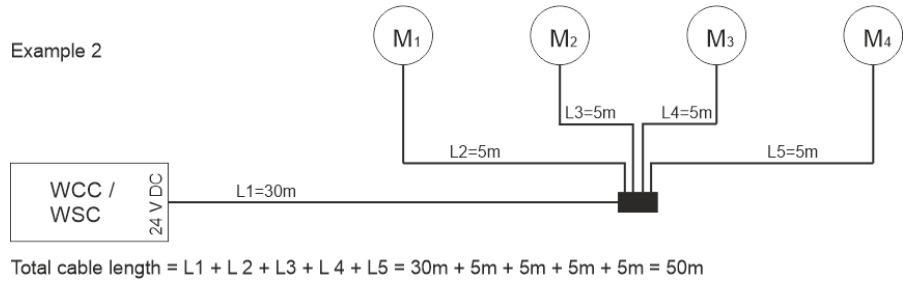
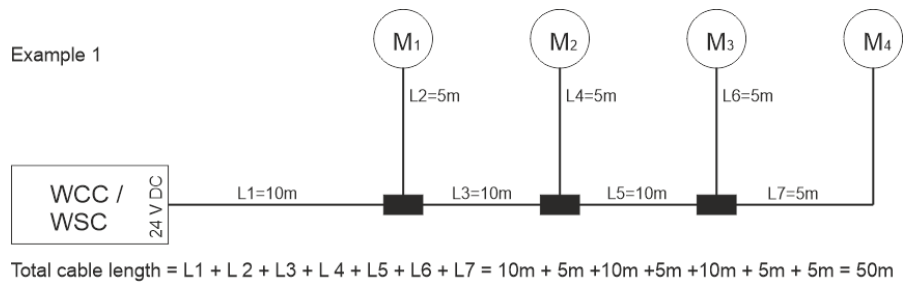

8.3.3 Max cable length – Pyrotechnic gas generator

Pyrotechnic gas generator**						
Do not use the PE wire / green/yellow wire!						
cable cross section [a]	3 wire * 0.75mm ²	3 wire * 1.50 mm ²	5 wire 1.50 mm ² 2 wire parallel	3 wire * 2.50 mm ²	5 wire 2.50 mm ² 2 wire parallel*	3 wire * 4.00 mm ²
Total actuator current [I]						
1A	42m	84m	168m	140m	280m	224m

* flexible stranded cores are only suitable with attached ferrules. Max 1 core / ferrule per terminal.

**FlexiSmoke™ has been tested with Chemring type 1.3.

9 Cable plan for connection to WSC 520 / WSC 540 / WSC 560

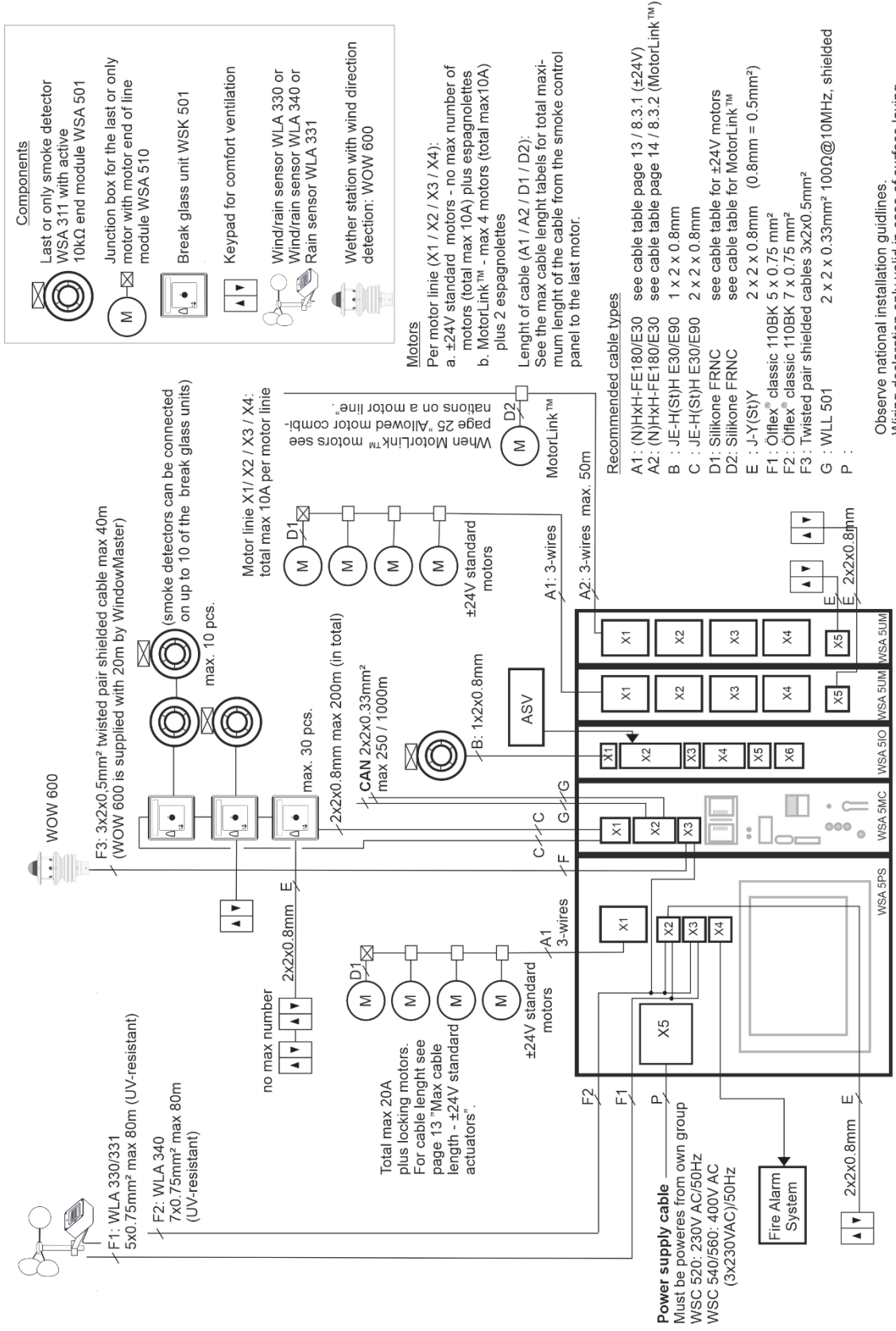

Observe national installation guidelines.
 Wiring declaration only valid in case of surface laying.

10 Description of modules

10.1 WSA 5PS power supply module 20A

Each 20A section has a WSA 5PS power supply module.

The module contains:

- one motor line (S1 X1) for $\pm 24V$ standard motors
- two free configurable inputs for connection of e.g., wind/rain sensor WLA 330 or keypad for comfort ventilation
- one output for additional power supply to sensors
- output for fault signal
- connection of power supply
- touch screen for configuration, commissioning and maintenance

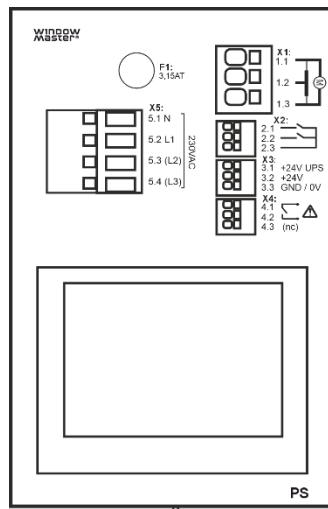

- X1: 1.1 } motor line S1 X1, 20A
1.2 } $\pm 24V$ std. motors
1.3 }
- X2: 2.1 } Open
2.2 } Close } input
2.3 } GND / 0V
- X3: 3.1 +24V UPS } AUX power
3.2 +24V }
3.3 GND / 0V }
- X4: 4.1 } fault signal to Fire Alarm System
4.2 }
4.3 (nc) }
- X5: 5.1 N } 230VAC
5.2 L1 } power supply
5.3 L2 }
5.4 L3 }

X1 For connection of $\pm 24V$ standard motors (total max 20A) and espagnolette actuators type WMB 801/WMB 802/811/812/815/816/817/818. All motors on motor line 'S1 X1' will run/be operated simultaneously. Connection / cable diameter: flexible max 6 mm² / solid max 10 mm². Cable length: see the chapter "Cable Sizing".

Examples with 20A power consumption

- 20 pcs. WMX 824-1
- 10 sets of 2 pcs. WMX 824-2
- 4 pcs. WMU 885-1
- 2 sets of 2 pcs. WMU 885-2

Connection of motors on motor line S1 X1

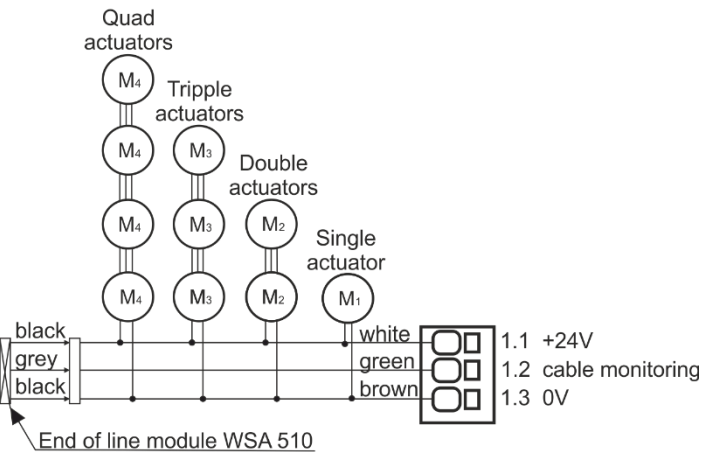

X2 For connection of wind/rain sensor type WLA 330 or WLA 340, rain sensor WLA 331, keypad, Fire Alarm System etc. For wind direction depending SHE - see chapter 10.2, section X3.

5PS.X2 is potential free / dry contact.

Data

- 2.1 Input
- 2.2 Input
- 2.3 GND / 0V

With the default values are input:

"Active" if the contact resistance is smaller than 4k Ω

"Inactive" if the contact resistance is bigger than 8k Ω .

For values between 4 and 8k Ω the result will depend on the supply voltage.

Input has pull up approx. 1mA. (min 0.7mA, max 1.4mA)

Input threshold is defaulted to "1200" equal to 6.2V, given at approx. 6k Ω .

The threshold can be set in the interval 0..4095 bit, approx. 5.2mV/bit

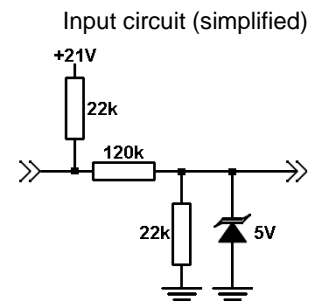

Example 1: Keypad and Fire Alarm System

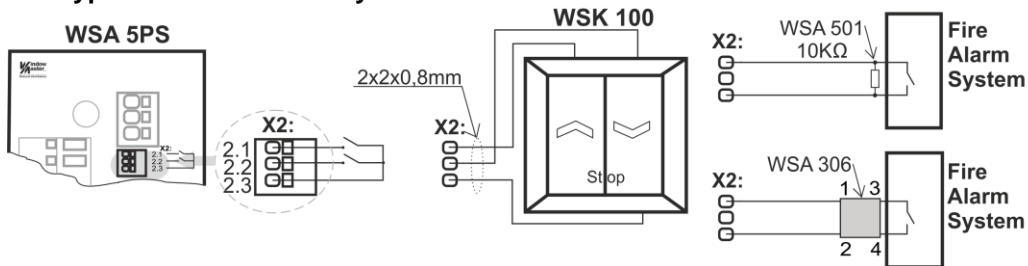

Use of cable monitoring e.g., from Fire Alarm System

If cable monitoring is not used, the input has only one threshold (G1).

If the input voltage is above this threshold it is inactive.

If the input voltage is under this threshold it is active.

Cable monitoring type "2"

Type "2" is used in conjunction with WSA 306.

This type of cable monitoring is the most secure because it detects both interruption and short circuit.

Limit values 2.8V, 0.26V and 12V are used.

Cable monitoring Type "1"

Type "1" is used with WSA 501.

This kind of cable monitoring detects only interruption.

Limit values 2.8V and 12V are used.

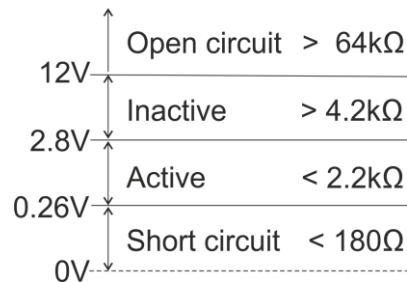

Threshold configuration	Short circuit	Active	Inactive (*)	Open circuit
Switch (no monitoring)	-	< 2.8V (<2.2kΩ)	> 2.8V (>4.2kΩ)	
Type 1: Cable monitoring with WSA 501	-	< 2.8V (<2.2kΩ)	> 2.8V (>4.2kΩ)	> 12V (> 64kΩ)
Type 2: Cable monitoring with WSA 306	< 0.26V (< 0.18kΩ)	< 2.8V (<2.2kΩ)	> 2.8V (>4.2kΩ)	> 12V (> 64kΩ)
Manual	0V - 22V	0V - 22V		0V - 22V

Resistance values based on 18V to 30V supply voltage

(*) Not configurable

Example 2: Wind/rain and rain sensors

WLA 330 and WLA 331 – the settings of the sensors are set on the sensor.

WLA 340 – the settings of the sensor are programmable on the smoke panels touch screen.

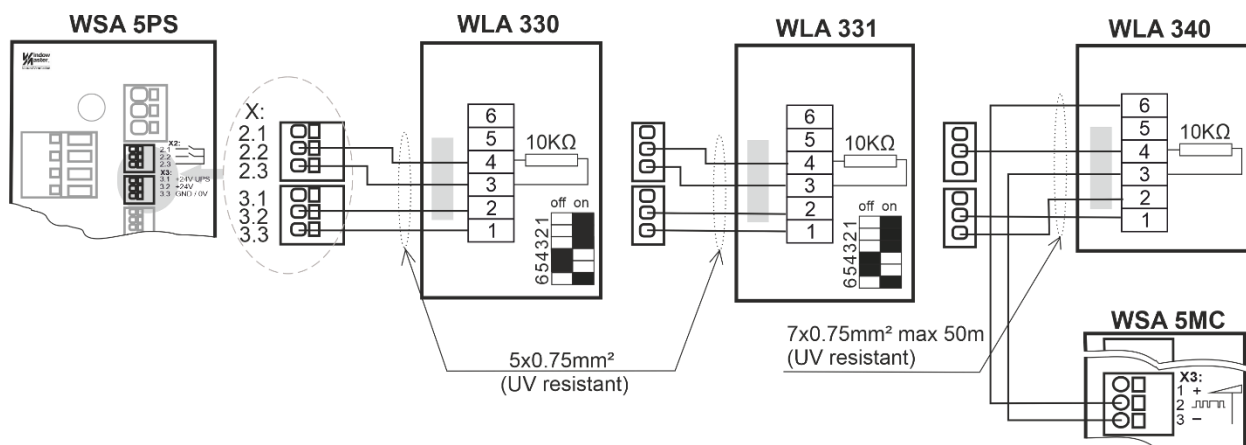

X3 Additional power supply for sensors etc.

3.1 min. 18V max. 29V additional power supply with back-up batteries, max current consumption 50mA

3.2 min. 18V max. 29V additional power supply without back-up batteries, max current consumption 200mA

3.3 GND / 0V

Only use additional power supply with additional power supply (X3.1) if really necessary, as this will influent on the life time of the back-up battery.

X4 Solid state output for transmission of fault signal.
 Closed contact = OK
 Open contact = Fault

A fault must last a minimum of 20 seconds before the relay indicate a fault.

Data

Max voltage: 30 Vp (peak)
 Max output: 150 mA
 Typical On-resistance: 4.7 Ω
 Max On-resistance: 8 Ω
 Max switching speed: 2 ms

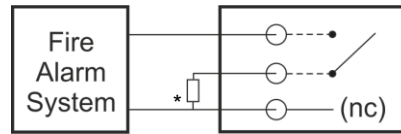

*depends on the fire alarm system cable surveillance

X5 Connection of power supply:
 WSC 520: 230V AC
 WSC 540: 2x230V AC, cables are connected in the first 20A section
 WSC 560: 3x230V AC, cables are connected in the first 20A section

Connection: cable diameter max 2.5 mm²

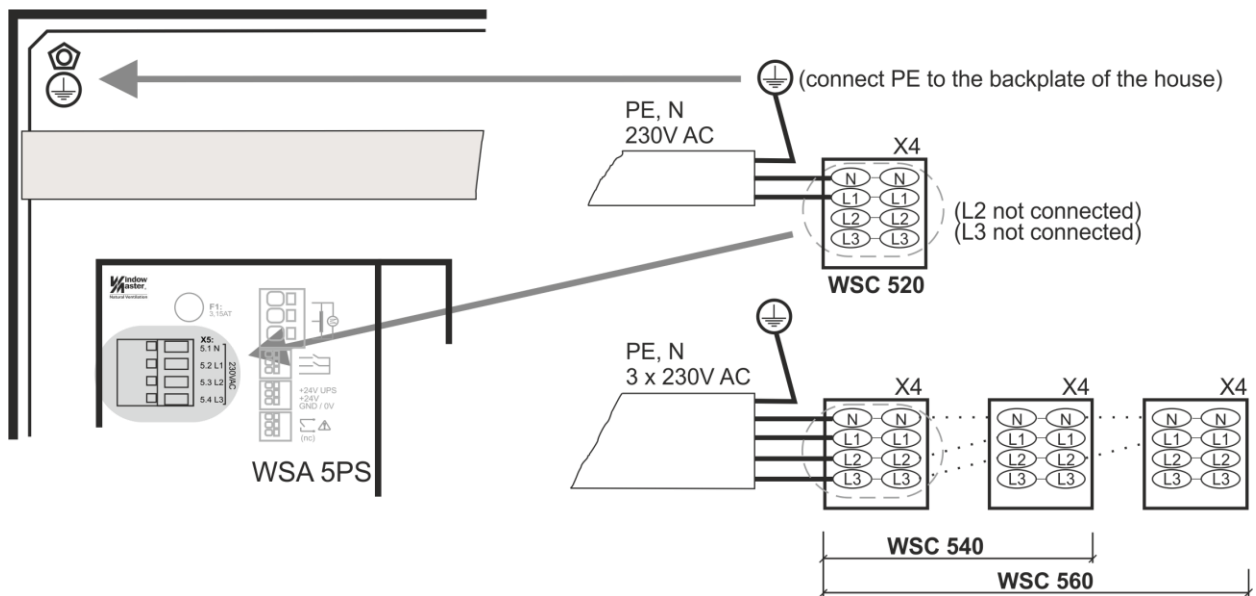

F1 Fuse 3.15A slow

10.2 WSA 5MC overall control module

Each 20A section contains an overall control module WSA 5MC.

The module is available with or without field bus interface for KNX.

The module can contain i.e.:

- input for break glass unit type WSK 50x
- CAN bus interface for connection of more smoke ventilation panels
- connection of weather station with wind direction detection
- LEDs for status of the smoke ventilation panel
- connection for field bus for KNX (only modules with communication)

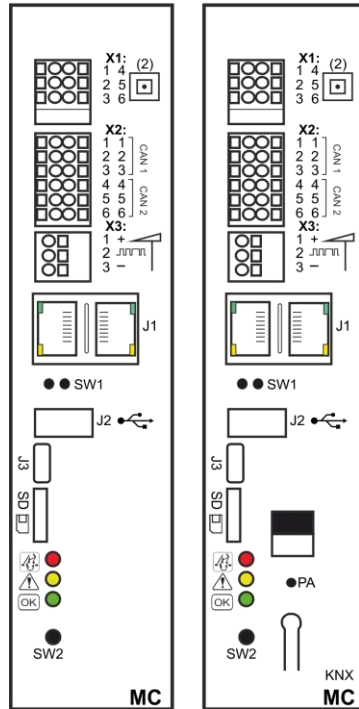

X1:	Break glass unit bus 1	Break glass unit bus 2	} break glass units WSK 501
1.1	24V	1.4 24V	
1.2	Lin	1.5 Lin	
1.3	GND/0V	1.6 GND/0V	
X2:	2.1	2.1 CAN 1 GND	} CAN 1
2.2	2.2 CAN 1 low	2.3 CAN 1 high	
2.3	2.3 CAN 1 high	2.4 CAN 2 GND	} CAN 2
2.4	2.4 CAN 2 GND	2.5 CAN 2 low	
2.5	2.5 CAN 2 low	2.6 CAN 2 high	
X3:	3.1	24V	} weather station with wind direction
3.2	communication		
3.3	GND / 0V		
J1:	2 x Ethernet		
SW1:	reset all		
J2:	USB host		
J3:	USB device		
SD:	SD-micro card		
KNX:	KNX connection		
LED1/2/3:	status of the smoke panel		
PA:	button for switching between normal and addressing mode for transferring the physical KNX address		
SW2:	(not connected)		

X1 For connection of WSK-Link™ units (break glass unit type WSK 50x or Fireman's override switch WSK 510).

Data

Break glass unit bus 1	Break glass unit bus 2
1.1 24V	1.4 24V
1.2 LIN1 (communication)	1.5 LIN2 (communication)
1.3 LIN1 GND / 0V	1.6 LIN2 GND / 0V

$I_{max} = 64mA$ when 30 break glass units and 100 smoke detectors.

As the break glass units are monitored, the connection of the break glass units depends therefore of the number of smoke zones.

The break glass units can always be connected in a ring but must, as a minimum:

- when 1 smoke zone - connect to break glass unit bus 1
- when 2 smoke zones - connect to break glass unit bus 1 respectively to break glass unit bus 2
- when 3 or more smoke zones - connect in ring

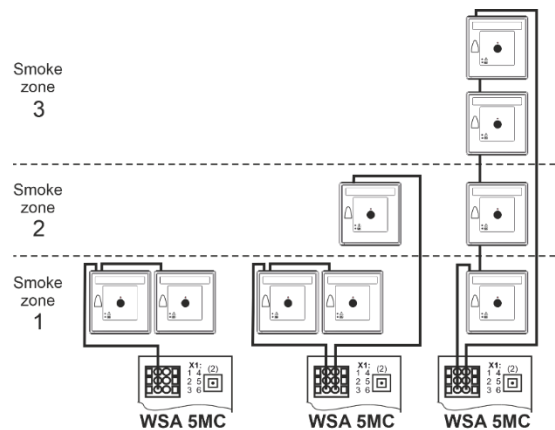

Smoke detectors and keypads are connected on the break glass unit type WSK 501/502.

Per 20A section up to 30 break glass units can be connected.

On max 10 of these 30 break glass units smoke detectors type WSA 311 can be connected - and max 10 smoke detectors per break glass unit. This gives a total of 100 smoke detectors per 20A section.

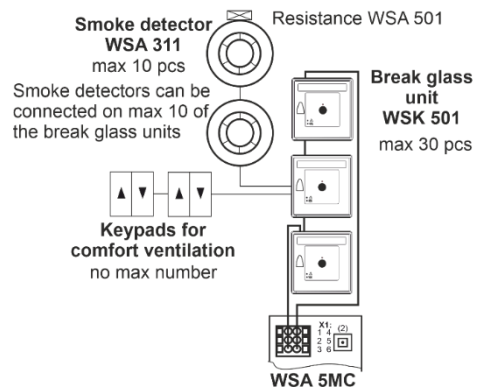

Example:

3 smoke zones and connected components; 2 break glass units WSK 501/502, 1 break glass unit type WSK 503/504, 3 smoke detectors WSA 311, 2 resistances WSA 501, and 2 ventilation keypads.

Example

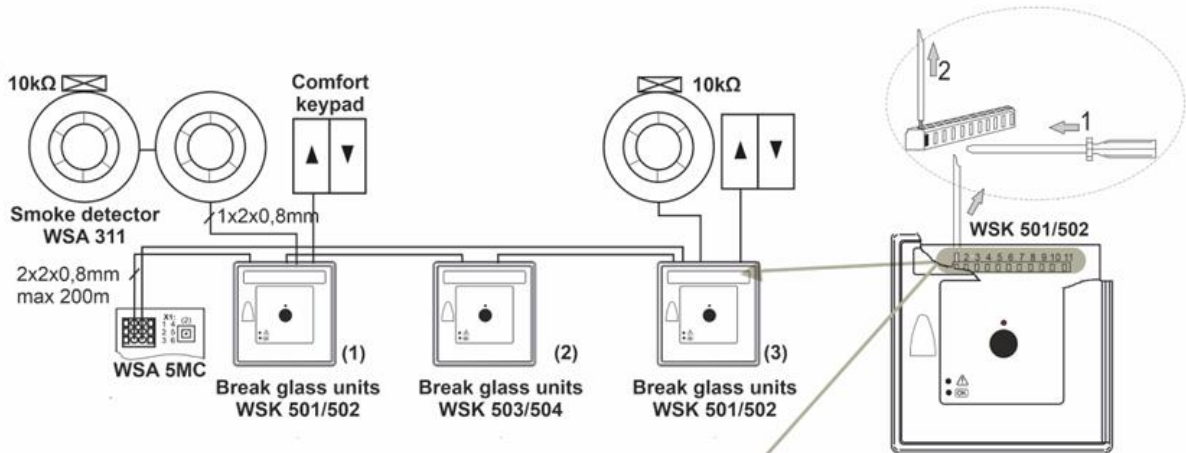

Wiring diagram for example

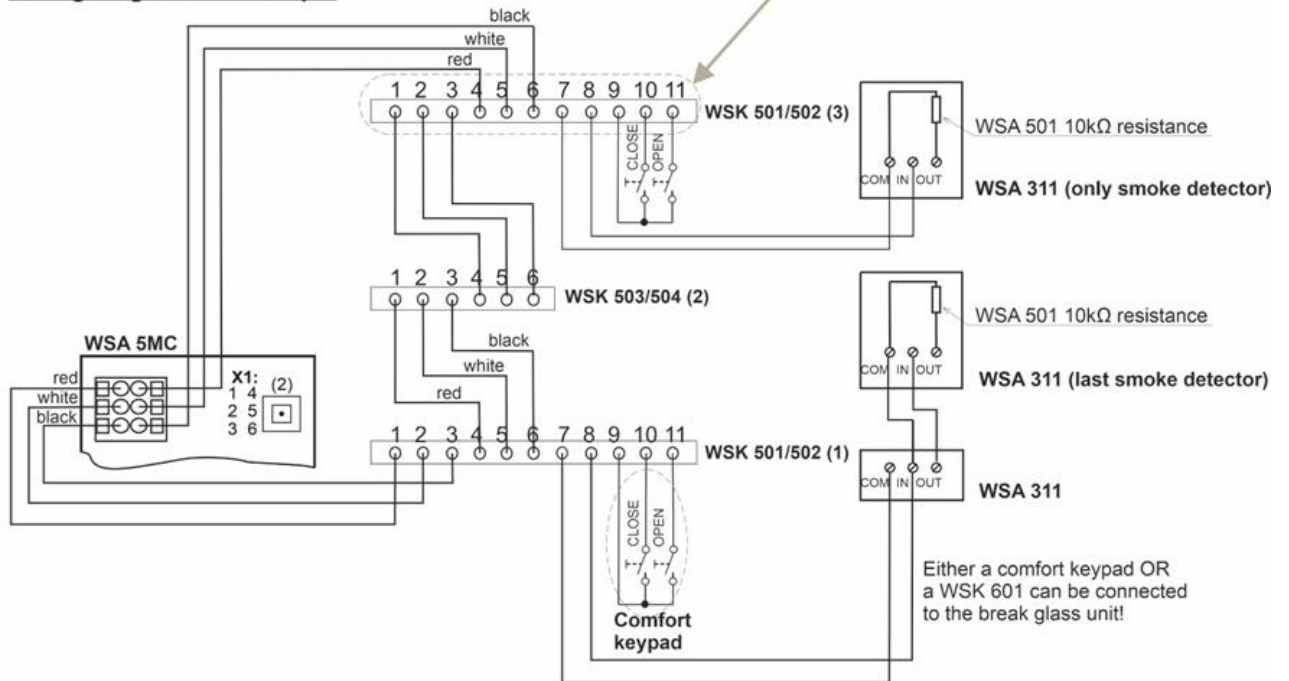

Notice:

WSA 501 10kΩ resistance:

- **NEVER** insert in the break glass unit but **ALWAYS** in the last or only smoke detector
- **NEVER** insert if no smoke detector is connected

See chapter 9 "Cable plan for connection to WSC 5xx" for cable types and lengths.

Connection to Fireman's override switch type WSK 510

The WSK 510 can be connected directly to the smoke panel or to a break glass unit type WSK 50x. The WSK 50x and the WSK 510 can be connected in an arbitrary order

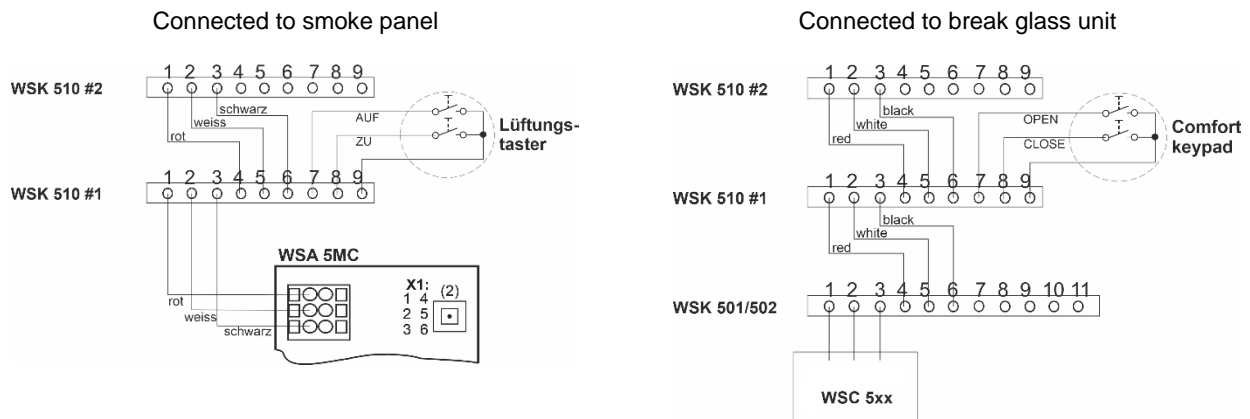

Comfort keypads can be connected to WSK 510. Smoke detectors cannot be connected to WSK 510. Please see WSK 510 instruction for configuration.

Connection of different types of smoke detectors to FlexiSmoke™

		Smoke detector type			
		WSA 300	WSA 311	Hekatron MSD 523 (max 5 pcs)	Hekatron SSD 521/a (WSA 200 6101)
Connect to WSA 5IO	X1,1	L1 In	In +	2	2
	X1,2	L2	Com -	1	1
Connect to WSK	p 7	L2	Com -	1	1
	p 8	L1 In	In +	2	2
ALWAYS connect 10 KOhm in between		L2 and L1 Out	Com - and Out +	1 and 3	1 and 3

X2 More FlexiSmoke™ smoke ventilation panels can be connected together via X2.

It is possible to connect up to 31 20A-sections

The smoke panels are coupled via X2 in the last 20A section in panel x to the first 20A section in panel x+1. See Section 9 "Cable plan for connection to WSC 5xx" and drawing below. The CAN cable between two smoke ventilation panels must not exceed 250m and the total cable length must not exceed 1000m.

When the panels are mounted in the same smoke zone the panels are connected via CAN1.

If the panels are mounted in two or more smoke zones the panels are connected via CAN1 and CAN2 in separate cables.

A red DIP switch is mounted on the back plane for the modules. Factory setting is set to OFF.

When connection more panels the switch on the first 20A section in the first panel and the switch on the last 20A section in the last section are to be set to ON.

Data

- 2.1 CAN1 GND
- 2.2 CAN1 L
- 2.3 CAN1 H
- 2.4 CAN2 GND
- 2.5 CAN2 L
- 2.6 CAN2 H

Communication:	closed CAN 2.0B network
Data speed:	10 kb/s
Coupling:	shielded CAN cable (e.g., cable type WLL 501, see accessories list)
Isolation:	galvanic separated
Cable impedance:	100Ω at 10MHz
Termination resistance:	120Ω (see below example with DIP-switch settings)
Cable dimension:	2 x 2 x 0.33mm2

Distance between smoke control panels

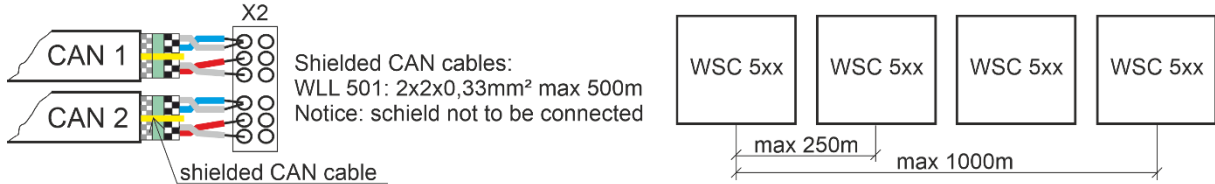

Example: coupled smoke control panels - in the same smoke area

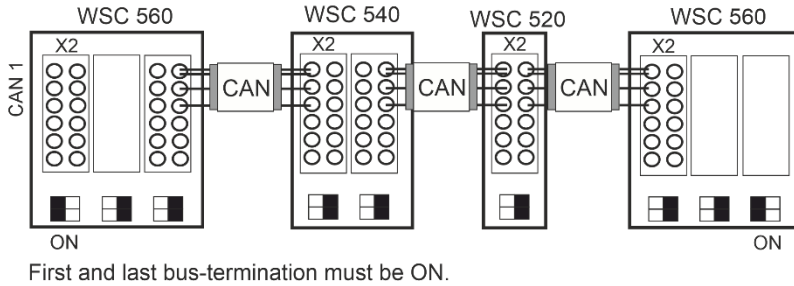

Example: coupled smoke control panels - in more smoke areas

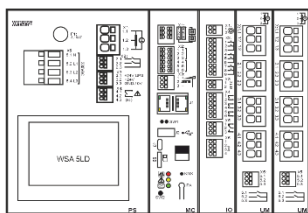
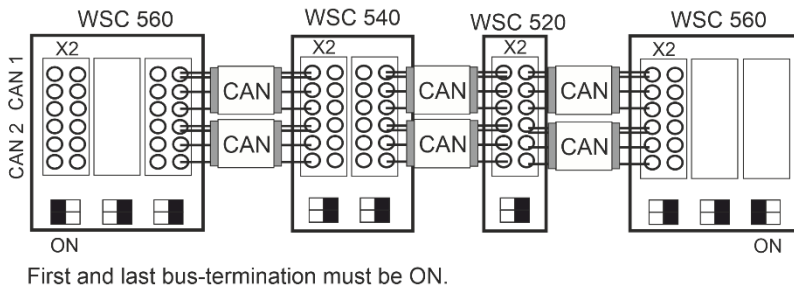

- DIP switch set to ON / ON
- DIP switch set to OFF / OFF (factory setting)
- DIP-switch mountes on the right side of the back plane for modules

X3 For connection of intelligent weather station (wind direction dependent ventilation).

The type of weather station is configured on the touch screen and can for example consist of: WOW 600 (weather station) or WLA 340 (wind speed and rain sensor).

The weather station can also be equipped with a pole and wall bracket for pole (not delivered by WindowMaster).

Data

- 3.1 Min 18V max 29V (depends on the mode of operation: mains / back-up batteries). I_{max} = 8mA
- 3.2 Communication
- 3.3 GND / 0V

As the weather station is monitored by both communication and time out (wind without time), any cable errors will be registered.

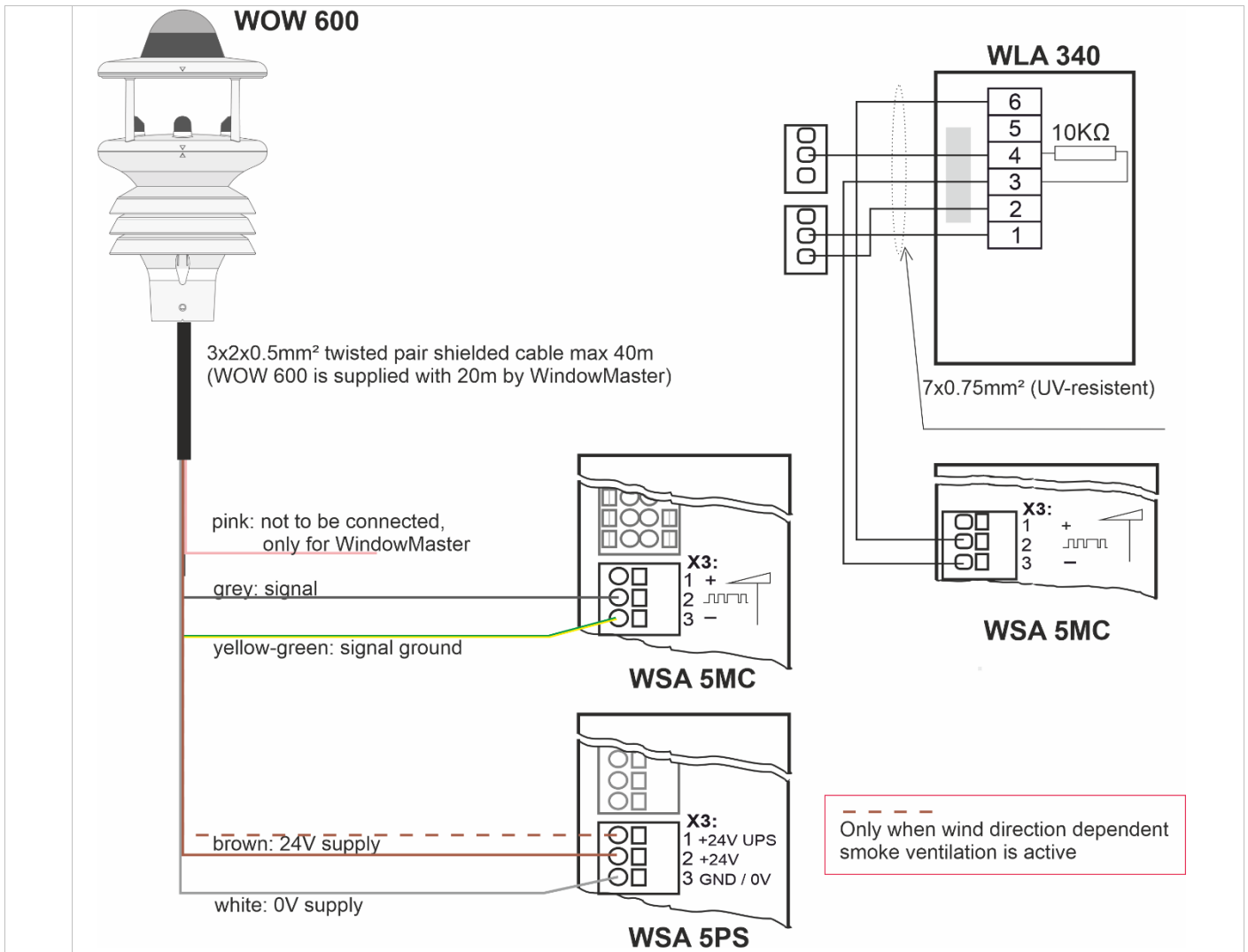

WOW 600 comes with 20m cable. The cable can be increased to 40m. The supplied cable can be used up to the vapor barrier. After the vapor barrier, there may be requirements for fireproof cables, so you must ensure that the installation complies with current national guidelines.

J1	Ethernet connection to remote configuration and BACnet IP communication *
SW1	Restart all. When activating SW1 the WSC 5MC in the current section will be restarted (configuration will not be lost). *
J2	USB host. Used to store configurations in USB stick. (prepared for later expansions) *
J3	USB device (prepared for later expansions) *
SD	SD-Micro card slot. * Used for log file and back up of the configuration of the panel. The card should NOT be removed.
LED	<u>Shows the status of the panel</u> Red = alarm Yellow = fault Green fast flickering = all OK (CPU working), Green constant = CPU communication stopped (possible reset or contact WindowMaster)
KNX	Connection of KNX communication bus (only on the WSA 5MC KNX module) *
PA	KNX button for switching between normal KNX operation and addressing mode (KNX)
SW2	Contact without function (prepared for later expansions)
*	J1, SW1, J2, J3, SD, KNX: When operated on back-up batteries these functions are closed down

10.3 WSA 5IO input/output module

The WSA 5IO module contains:

Inputs

- 1 connection for external smoke detector when no break glass unit is connected
- 3 free configurable inputs for connection of e.g., keypads for comfort ventilation or inputs from Fire Alarm System
- 1 24/48V Fire Alarm System – primarily used in France

Outputs

- 3 free configurable solid state outputs
- 1 free configurable potential free output for connection to e.g., Fire Alarm System or other systems

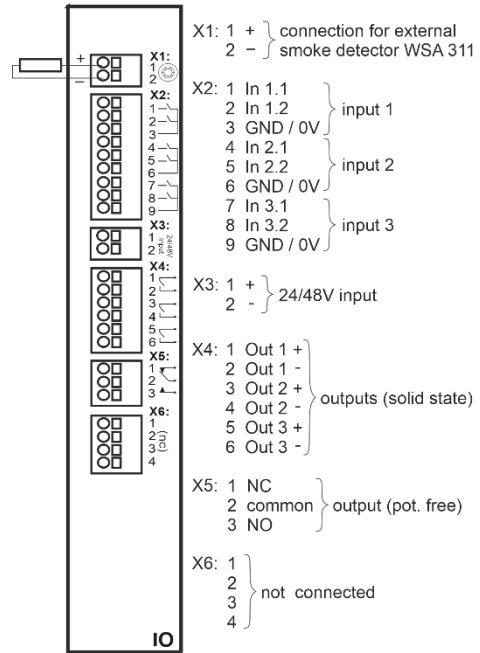

X1 For connection of smoke detector type WSA 311 and WSA 300.
I_{max} = 3.4mA

Connection of WSA 311

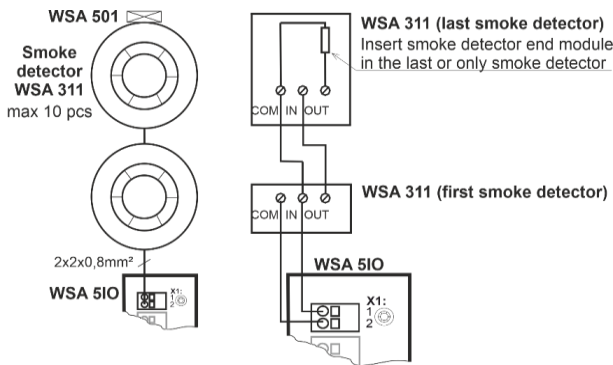

Connection of WSA 300

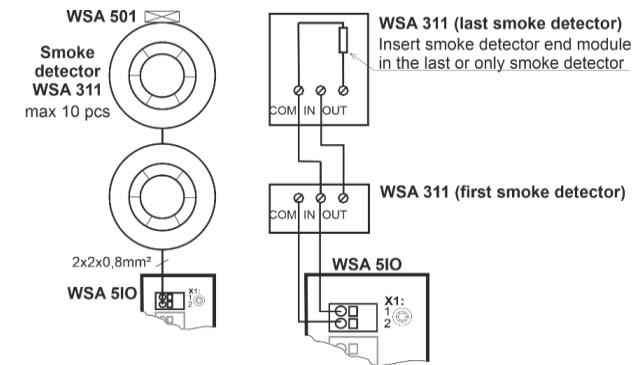

For connection of a different type smoke detector, see the example in section 10.2

X2 Three times two free configurable inputs.
5IO.X2 is potential free / dry contact.

Input 1

- 2.1 input 1.1
- 2.2 input 1.2
- 2.3 GND 1 / 0V

Input 2

- 2.4 input 2.1
- 2.5 input 2.2
- 2.6 GND 2 / 0V

Input 3

- 2.7 input 3.1
- 2.8 input 3.2
- 2.9 GND 3 / 0V

Connection examples: keypad and Fire Alarm System

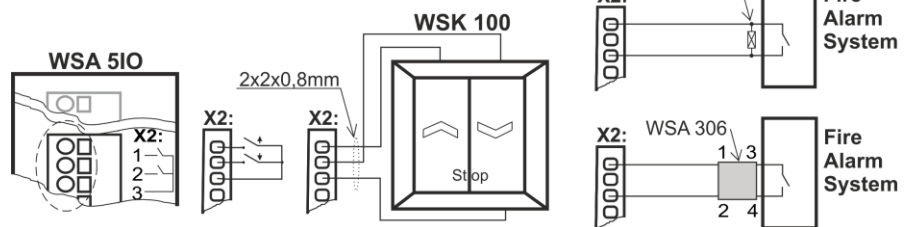

Fire Alarm System shown with cable monitoring type 1 and type 2:

Cable monitoring Type "1"

Type "1" is used with WSA 501.
This kind of cable monitoring detects only interruption.

Cable monitoring type "2"

Type "2" is used in conjunction with WSA 306.
This type of cable monitoring is the most secure because it detects both interruption and short circuit.

See Chapter 10, Section 10.1, point X2 for detailed explanation about input options, cable monitoring, etc.

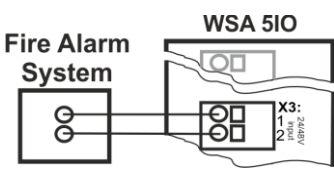
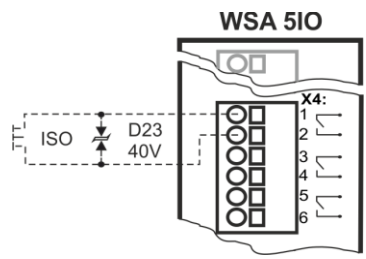
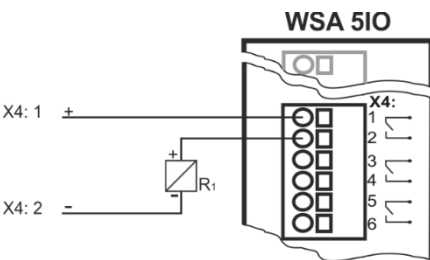
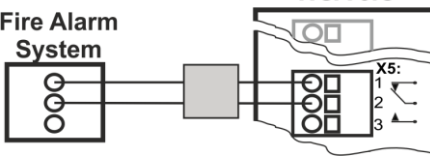
<p>X3</p>	<p>24/48V free configurable input from e.g. Fire Alarm System (used primarily in France).</p> <p><u>Data</u> Active at voltages between 18 and 50V Passive below 1V Max.50V</p>	<p>Connection example</p> 
<p>X4</p>	<p>3 free configurable solid state outputs</p> <p>4.1 Output 1 4.2 Output 1 4.3 Output 2 4.4 Output 2 4.5 Output 3 4.6 Output 3</p> <p><u>Data</u> Max voltage: 30 Vp (peak) Max current: 150 mA Typical On-resistance: 4.7 Ω Max On-resistance: 8 Ω Max switching speed: 2 ms, only for DC-voltage</p>	<p>Output circuit (simplified)</p>  <p>Example with solid state and relay</p> 
<p>X5</p>	<p>Free configurable potential free output. Free configurable potential free relay output for connection of e.g., Fire Alarm System or siren.</p> <p>5.1 NC = normally closed 5.2 Common 5.3 NO = normally open</p> <p>Max DC voltage : 30 Volt Max AC voltage : 100 Volt Max current: 1A</p>	<p>Remember cable monitoring – see the Fire Alarm System</p> 
<p>X6</p>	<p>Not used</p>	

10.4 WSA 5UM universal motor module

WSA 5UM motor module provides:

- 4 motor lines for either $\pm 24V$ standard motors or motors with MotorLink®
- 1 x 2 free configurable inputs for connection of e.g., keypad or wind/rain sensor

Only panels from version E5 contains the universal motor module. For configuration of WSA 5ML or WSA 5SM modules please see earlier version instruction manual.

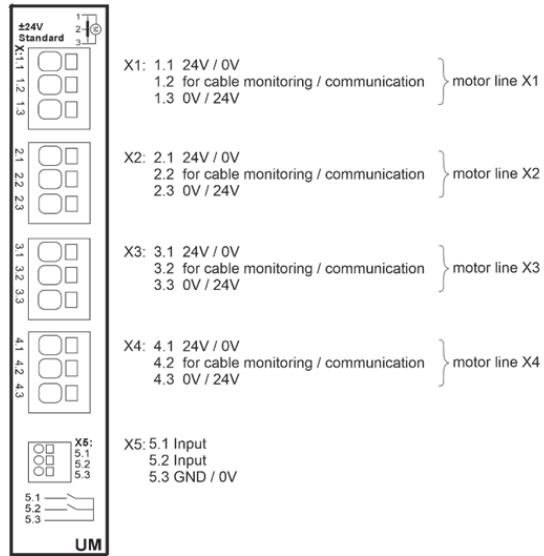

X1 Motor line X1, X2, X3 and X4

The WSA 5UM module has four motor lines (X1, X2, X3 and X4) for connection of $\pm 24V$ standard motors or motors with MotorLink®.

On each motor line motors with a total power consumption of max. 10A can be connected; however, the total max power consumption for all four motor lines must not exceed 20A.

Besides motors also locking motors (espagnolette motors) type WMB 801/802/811/812/815/816/817/818 can be connected. The power consumption of the locking motors is not to be included in the 20A as motors and locking motors do not run at the same time.

All motors on the same motor line will drive/be operated simultaneously.

All motors on the same motor line must be of the same type.

For cable length see chapter "Cable dimensioning".

Cable diameter: flexible max 6mm², solid 10mm. Flexible stranded cores are only suitable with attached ferrules. Max 1 core / ferrule per terminal.

If cable monitoring is required a "Motor end of line module" type WSA 510 is to be added. When using non-WindowMaster the cable monitoring is set to "simple", see section 11.1".

Standard $\pm 24V$ motors

Examples with max 20A power consumption:

- 2 sets of 10 pcs. WMX 826-1
- 2 sets of 5x2 pcs. WMX 826-2
- 4 pcs. WMU 885-1
- 2 sets of 2 pcs. WMU 885-2

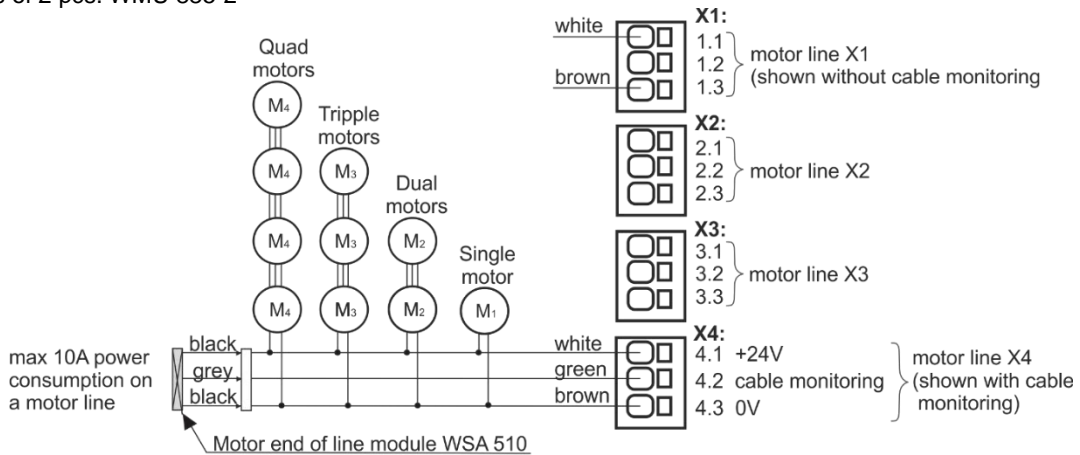

MotorLink® motors

Examples with motors per motor line:

Ex. 1: 4 pcs. WMX 826-1

Ex. 2: 2 pcs. WMX 826-2

Ex. 3: 2 pcs. WMU 885-2

Connect the motors accordingly to the drawing below.

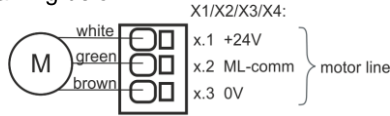

ML-comm = MotorLink™ communication

Allowed motor combinations on a motor line

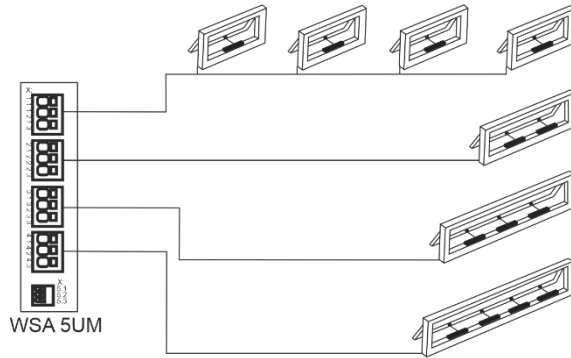

-1 (single): One window with one single window actuator. Up to four windows each with one single window actuator can be connected.
(e.g. 1 x WMX 804-1* up to 4 x WMX 804-1).

-2 (double): One window with two double window actuators. (e.g. 2 x WMX 804-2)*.

-3 (triple): One window with three triple window actuators (e.g. 3 x WMX 804-3)*.

-4 (quad): One window with four quad window actuators (e.g. 4 x WMX 804-4)*.

* Up to two locking actuators type WMB 81x-n can be installed on a window (max. one single or two double WMBs on each motor line) - see product sheet for valid actuator combinations.

X5 Potential free connection for e.g., keypads, wind/rain sensor or rain sensor, if they are not connected on the WSA 5PS module. Connection for power supply for the wind/rain or rain sensors are still at WSA 3PS X3.

Data

Cable diameter: max 1.5 mm²

5.1 Input

5.2 Input

5.3 GND / 0V

See Chapter 10, Section 10.1, point X2 for detailed description about input options, cable monitoring etc.

Examples

- WSK 100 keypad for comfort ventilation

- WLA 330 wind/rain sensor

- WLA 331 rain sensor

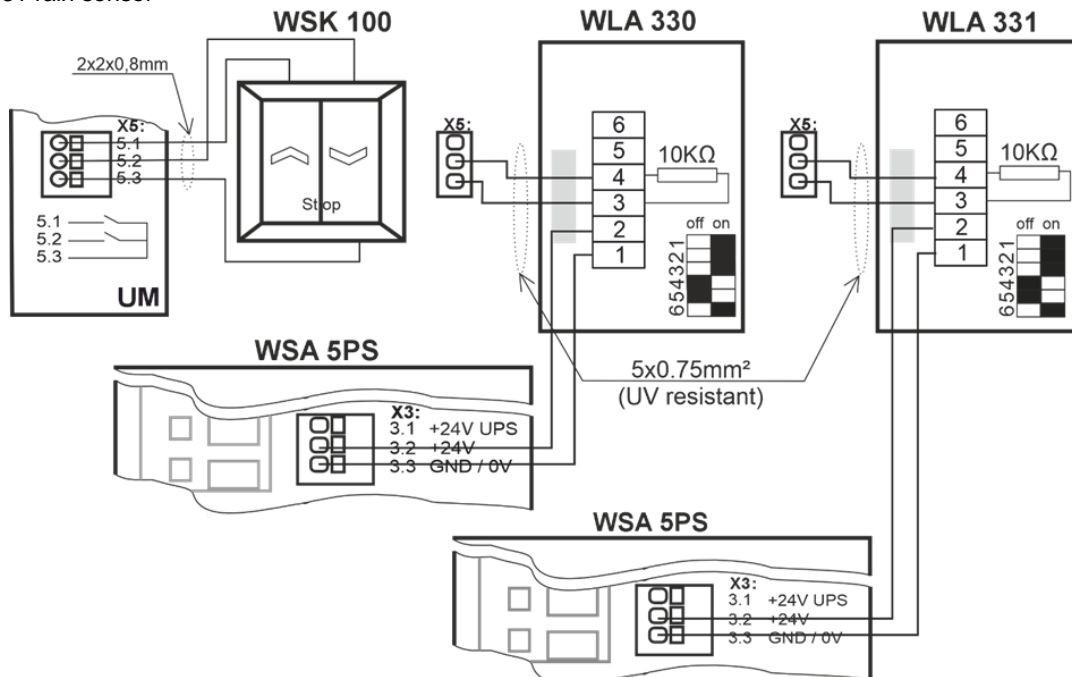

11 Cable monitoring of motors

Motors with MotorLink® are monitored by data communication.

When using ±24V standard motors either diodes or 10kΩ resistors can be used for cable monitoring, see below.

Configuration of cable monitoring with ±24V motors

<input checked="" type="checkbox"/> Configuration, Motor line, S5 X1: Wire cable check type	
<input checked="" type="checkbox"/> Diodes (WSA 432)	<input type="checkbox"/> 10k0hm resistors (WSA 510)
<input type="checkbox"/> 10k0hm resistors, simple (WSA 510)	
<input type="checkbox"/> <input checked="" type="checkbox"/>	

Configuration of cable monitoring

Diodes (WSA 432) – monitors ever single core for interruption. Works with all WindowMaster motors.

WSA 5UM X1/X2/X3/X4

Note: short circuit between +24V (x.1) and monitoring wire (x.2 ML-comm) as well as breakage on +24V (x.1) cannot be detected.

WSA 510 (WindowMaster standard) – monitors ever single core for interruption. Works with all WindowMaster motors.

Simple WSA 510 – monitors for interruption on the entire cable. Works with all WindowMaster motors and some non-WindowMaster motors.

WSA 5UM X1/X2/X3/X4

Note: any short circuit or breakage on monitoring wire (x.2 ML-comm.) cannot be detected.

11.1 Usage of non-WindowMaster motors

When using non-WindowMaster motors the cable monitoring is set to "simple".

Configuration of cable monitoring with non-WindowMaster motors

<input checked="" type="checkbox"/> Configuration, Motor line, S5 X1: Wire cable check type	
<input type="checkbox"/> Diodes (WSA 432)	<input type="checkbox"/> 10k0hm resistors (WSA 510)
<input checked="" type="checkbox"/> 10k0hm resistors, simple (WSA 510)	
<input type="checkbox"/> <input checked="" type="checkbox"/>	

Configuration of cable monitoring

If cable monitoring of non-WindowMaster® motors connected to the FlexiSmoke™ is required the cable monitoring type is set to "simple".

Note: A few types of non-WindowMaster motors cannot run together with FlexiSmoke™, due to the cable monitoring control voltage. These motors can be brought to run, in some cases, if the cable monitoring in the 4 motor lines of the module are switched off and a 390Ω / 5Watt resistor is mounted on each of the motor lines in use.

12 Back-up batteries

Connect 2 pcs. back-up batteries type WSC 017 for each 20A section.

See chapter 23 "Maintenance" for further information.

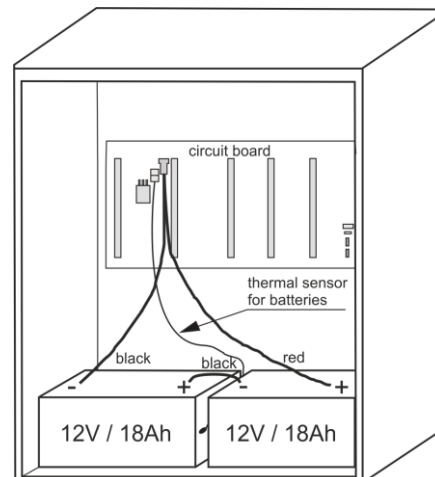

It is possible to deselect the emergency power batteries if the panel can be supplied from a 230V emergency power system such as a UPS or a 230V No-break system.



The emergency power system must fulfil the requirement for secondary supply in EN 12101-10 section 6.2.

Specifically, the emergency power system must be able to keep the panel in operation for at least 72 hours, after which it must be able to supply 20A for 180 seconds.

IMPORTANT - If 230V emergency power is used, there must NOT be any interruption of supply when switching from 230V supply to emergency power supply.

Deselecting emergency power batteries is configured under the menu item "See all details" "System".

12.1 Measurement of battery charging voltage

 View all details, Power supply Mains status OK Battery status OK Back-up batteries voltage 27.4 V Power supply voltage 27.6 V  	<ol style="list-style-type: none"> 1. Select "Power supply" under „View all details” 2. Read the "Back-up batteries voltage” 3. Connect a voltmeter to the batteries and read the the batter voltage 4. Compare the two values, if no error is indicated on the panel (green icon) AND the difference between the two values is less than 250mV, then the charger is okay.
--	--

13 Touch screen

The smoke ventilation panel comes with one touch screen per 20A section i.e., that WSC 520 comes with one screen, WSC 540 with two screens and WSC 560 with three screens.

All connected components (motors, break glass units, keypads, weather station etc.) are to be configured on the touch screen. On the WSC 540 (two touch screens) and the WSC 560 (three touch screens) the components can either be configured on the touch screen in the section that they are connected or they can be configured on the other touch screen(s) in the smoke ventilation panel.

The menu of the touch screen is in steps:

Step 1: main menu

Step 2: sub menu

Step 3: configuration / showing / operation of the sub menu

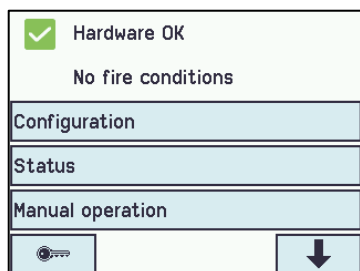

Step 1: Main menu

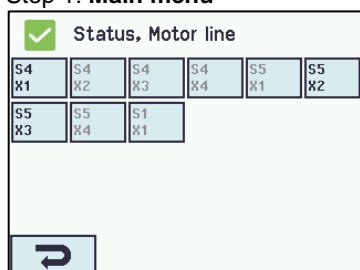

Step 3: **Overview** of objects which are to be configured

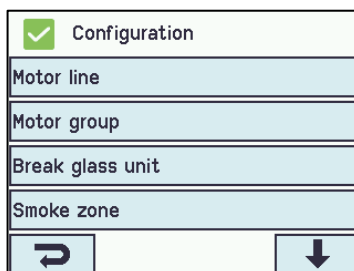

Step 2: Sub menu

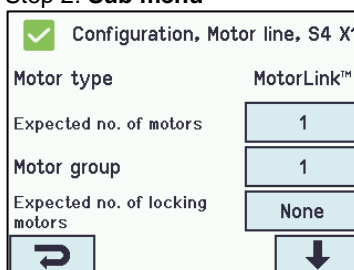

Step 4: **Configuration** of the sub menu

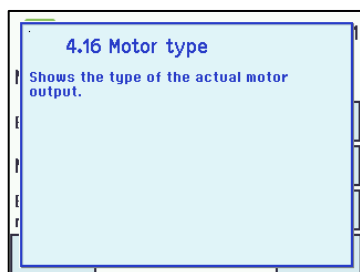

Help text

Help text

The touch screen has a help function with text explaining the menu item.

The help text occurs when the menu item is pressed (text on white background).

For displaying the help text:

→ press the item e.g., "Motor type"

→ the help text appears

→ to turn off the help text press the screen.

13.1 Icons

The smoke ventilation panel has icons for quick viewing of: fire conditions, hardware OK and hardware error:

 **Fire conditions:** smoke alarm has been triggered.

 **Hardware OK:** motors and break glass units have been configured correctly.

 **Hardware error:** hardware error or connected motors and break glass units has not been configured correctly in motor lines, motor groups or smoke zones.

13.2 Rotation of the touch screen

The picture on the touch screen can be rotated 180°

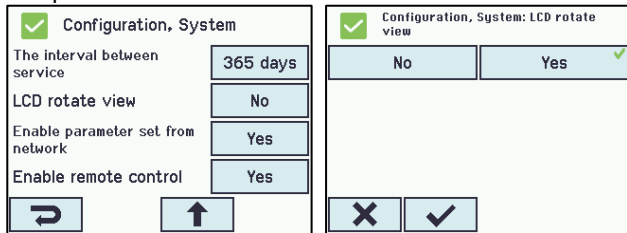

14 Configuration – main menu

All connected components (motors, break glass units, keypads, weather station etc.) are to be configured.

As the panel has pre-settings for PIN code for access to level 4, the code is to be entered before it is possible to begin the configuration (see chapter 2.1 “Log in”).

Before starting on the configuration, it can be an advantage to change some of the pre-set settings. Ex. the language can be changed from English to Danish or German (see section 14.19 “System”) and the orientation of the text on the touch screen can be rotated for a better viewing angle (see section 13.2 “Rotation of the touch screen”).

It is also possible to change the log out time, which is the time that the access to the access level is open/the touch screen in on (see section 2.1 “Log in”).

To configure a sub menu:

- press the light blue number field
- enter value / the number of the motor line / change factory settings etc. The setting which can be entered depends of the type of the sub menu.
- accept on

A menu can consist of more screen plays. To get to the next screen: → press

14.1 Motor lines – motor groups – smoke zones

All the components are to be assigned to groups and zones:

- motor lines are to be assigned to motor groups
- motor groups can be assigned to smoke zones
- break glass units and smoke detectors are to be assigned to smoke zones
- keypads are to be assigned to one or more motor groups

14.1.1 Examples with motor lines / motor groups / smoke zones

- 7 motor lines: one or more motors connected to the lines
- 4 motor groups: the motors in the motor group are operated simultaneously on the keypad
- 3 smoke zones: the motors in the smoke zone are operated simultaneously on the break glass unit

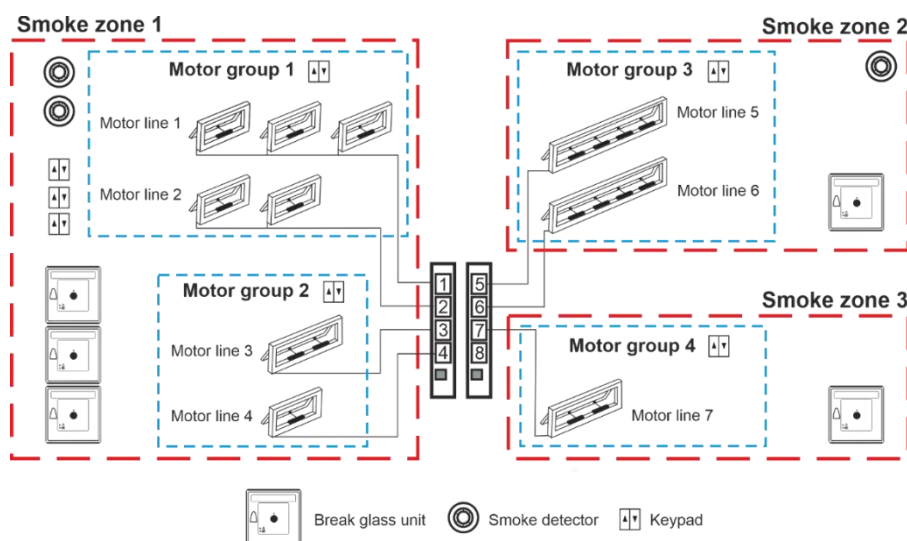

14.2 Motor line

Motors are to be connected on the motor lines.

Depending the type of module either ±24V standard motors or motors with MotorLink® can be connected.

14.2.1 Motor line - numbering

All motor lines are numbered, and they are all to be configured.

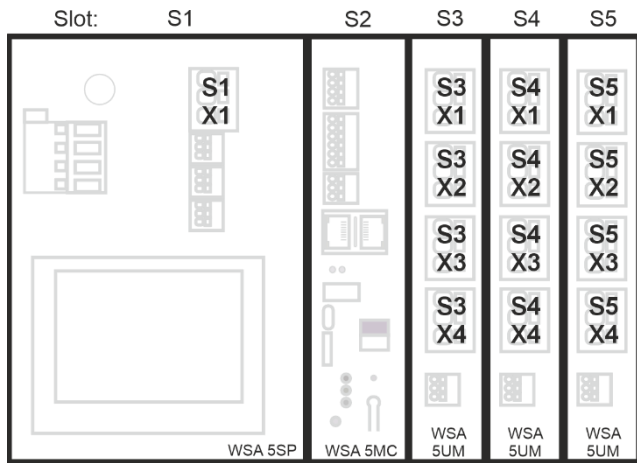

14.2.2 Motor line - configuration

Press "Motor line" and the overview of the motor lines in the smoke ventilation panel is shown.

Overview configuration motor lines

Configuration, Motor line

All	S1 X1	S4 X2	S4 X3	S4 X4	S5 X1
S5 X2	S5 X3	S5 X4	S1 X1		

One motor line is marked with a as the configuration is missing.

Configuration, Motor line

All	S4 X1	S4 X2	S4 X3	S4 X4	S5 X1
S5 X2	S5 X3	S5 X4	S1 X1		

All motor lines are configured.

All motor outputs on the motor module as well as the single motor output S1.X1 on the WSA 5PS module are to be configured:

- Motor lines with motors connected are to be configured in "motor group"
- Motor lines with no motor connected are set to "none"

Since $\pm 24V$ motors and motors with MotorLink[®] are not to be configured exactly the same way, both type of motors are listed below with the settings that are to be configured for each motor type.

Be aware that both types of motors can be connected to the smoke panel at the same time.

For $\pm 24V$ motors the full chain length is defined as a runtime of 60 seconds. To ensure the windows are 100% open or closed, the chain length is run twice (120sec). This can have an influence when configuring the sequence control.

Motor lines configuration

Configuration, Motor line, S5 X1

Output mode $\pm 24V$ motor

Motor configuration No cable monitoring

Stroke time 50 s

Motor group -

$\pm 24V$ motor configuration

The $\pm 24V$ motors are to be configured in:

1. Output mode: informs the type of motor selected
2. Motor configuration
3. Stroke time
4. Motor group
5. Manual command - auto off-period
6. Retry during alarm
7. Sequential control type

The appendix contains all the menus that can be configured - see appendix for detailed explanation.

The MotorLink® motors are to be configured in:

Configuration, Motor line, S4 X1

Output mode	MotorLink™
Expected no. of motors	1
Motor group	1
Expected no. of locking motors	None

MotorLink® motor configuration

The MotorLink® motors are to be configured in:

1. Output mode: informs the type of motor selected
2. Expected no. of motors
3. Motor group
4. Expected no. of locking motors
 - 4.1 No. of found locking motors (see appendix)
5. Manual speed
6. Auto. speed
7. Manual command – auto off period
8. Retry during alarm
9. Max unexpected overcurrent
10. Max unexpected overcurrent (motor)
11. Sequential type

The appendix contains all the menus that can be configured - see appendix for detailed explanation.

14.2.3 Colour code - motor line

The overview fields on the touchscreen have colour codes for the motor lines:

Colour	Meaning
Yellow triangle icon 	The motor line is to be configured or there is a fault in the motor
Strikethrough grey	No configuration of the motor line / the motor line doesn't exist
Black text	The motor line is configured, the motor has not been closed 100%
Green	The motor line has been configured; the motor has been closed 100%. Motor lines on the MotorLink® module will be marked in green, if the motor/motors on the motor line have been closed 100% and the point zero of the motor has been determined.
Light grey number	The motor line is configured with 'No motors are connected'
Blue ?	Configuration is missing or there is a mistake in the configuration
Red	The motor line has been given alarm signal

14.3 Motor group

All motor groups can be assigned to a smoke zone and multiple motor groups can be assigned to the same smoke zone.

See the example "Example of motor lines / motor groups / smoke zones" in the beginning of this chapter for further details or the utilization examples, which can be found on the home pages.

When configuration specify the number of the smoke zone that are to control the motor group.

14.3.1 Motor group - configuration

Press "Motor group" and the overview of the motor groups in the smoke ventilation panel is shown.

Motor group configuration

Configuration, Motor group

1	2	3	4	5	6
7	8	9	10	11	12
13					

Motor group overview

Motor groups are to be configured in:

1. Controlling smoke zones
2. Comfort open position
3. Comfort open close time
4. Use 'safety' from smoke zone
5. Wind directions where windows are to close during alarm

The appendix contains all the items that can be configured - see appendix for detailed explanation.

14.3.2 Colour code – motor group

The overview fields on the touch screen have colour codes for the motor groups:

Colour	Meaning
Yellow triangle icon 	One or more of the assigned motor lines has a failure
Black text	The motor group is configured
Green field	All the assigned motor lines are closed
Light grey number	The motor group is configured but no motor lines are assigned
Blue ?	Configuration is missing or there is a mistake in the configuration
Red	The motor group has been given alarm signal

14.4 Break glass unit

A break glass unit shall be assigned to a smoke zone and multiple break glass units can be assigned to the same smoke zone.

See the example "Example of motor lines / motor groups / smoke zones" in the beginning of this chapter for further details.

14.4.1 Break glass unit – configuration

First the break glass units must be configured according to the topology (if they are connected one by one or in a ring) and then follow the individual configuration of the break glass units according to smoke zones, comfort motor groups etc.

To be sure it is the right glass break unit that is configured; it is possible to locate the break glass unit in one of two ways:

1. Press the reset button and a blue speech bubble will appear in the selected break glass unit in the overview of the break glass units.
2. Press the number of the selected break glass unit on the overview on the touch screen → press  until the menu point appears – “bip 1min for locating” is shown → press “No” → select “Yes”. The selected break glass unit will now beep if the door on the break glass unit is closed.

Topology

The break glass units are monitored and the connection of the break glass units to the smoke ventilation panel depends of the number of smoke zones:

1. when 1 smoke zone the break glass units are connected in series and connected directly to the WSA 5MC module
2. when 2 smoke zones the break glass units are connected in each their series and connected directly to the WSA 5MC module
3. when 3 or more smoke zones the break glass units are coupled in a ring

See section "10.2 WSA 5MC overall control module" item "X1" for further information on connection of break glass units.

Note: The break glass unit must be set in ring and the setting to "Yes" to have the error indication on the 'All' (group field) on the overview of the break glass units.

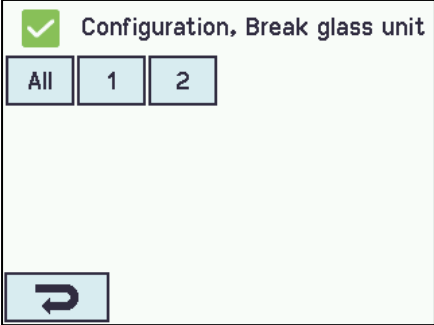
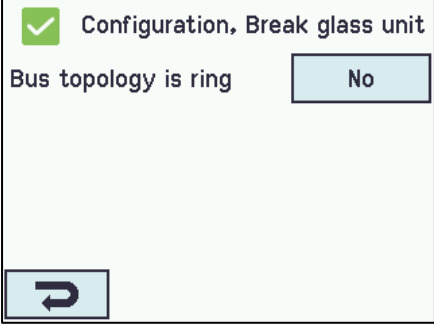
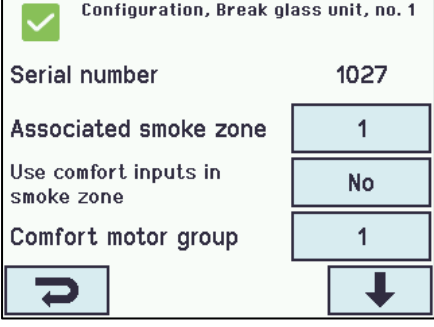
Break glass unit configuration	
 <p>Overview 'Break glass units</p>	<p>Overview 'Break glass units</p>
Break glass units are to be configured in:	
 <p>Configuration of 'Topology'</p>	<p>'All'</p> <ol style="list-style-type: none"> 1. Bus topology is ring - see text about "Topology" below <p>The appendix contains all the items that can be configured - see appendix for detailed explanation.</p>
 <p>Configuration of a selected 'Break glass unit' - shown for no.1</p>	<p>The numbered break glass units</p> <ol style="list-style-type: none"> 1. Serial number: the break glass unit's unique serial no. is shown (cannot be configured) 2. Associated smoke zone 3. Use comfort inputs in smoke zone 4. Comfort motor group 5. Br.glass unit+sensor same smoke zone <ol style="list-style-type: none"> 6.1 Smoke sensor associated with smoke zone (<i>displayed only if 'Other smoke zone' is selected</i>) 6. Unit beep 1min for locating 7. Delete this unit <p>The appendix contains all the items that can be configured - see appendix for detailed explanation.</p>

14.4.2 Colour code – break glass unit

The overview fields on the touch screen have colour codes for the break glass units:

Colour	Meaning
Yellow triangle icon 	Sensor error
Black text	The break glass unit are assigned to a smoke zone
Blue speech bubble	The reset-button in the break glass unit is pressed down (used when detecting break glass unit)
Light grey number	The break glass unit is not assigned to a smoke zone
Blue ?	Configuration is missing or there is a mistake in the configuration
Red	The alarm button in the break glass unit is pressed down (alarm signal)

14.5 Smoke zone

Configuration of master/slave and control zones. Configuration of different opening limits of the windows when alarm is triggered.

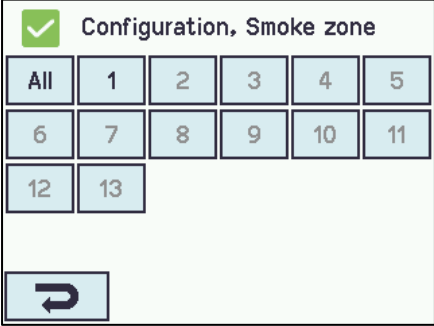
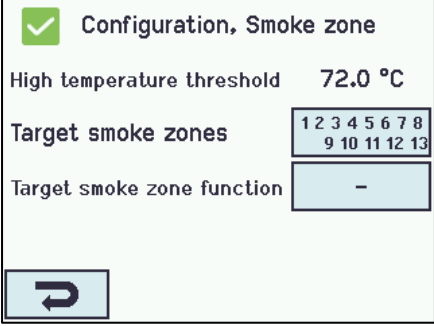
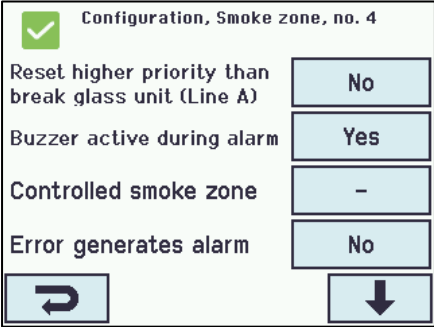
Smoke zones configuration	
 <p>Overview 'Smoke zones'</p>	<p>Overview 'Smoke zones'</p>
The smoke zone is to be configured in:	
 <p>Configuration of 'All'</p>	<p>All</p> <ol style="list-style-type: none"> 1. High temperature threshold 2. Target smoke zones 3. Target smoke zone function <p>The appendix contains all the items that can be configured - see appendix for detailed explanation.</p>
 <p>Configuration of a specific 'Smoke zone'</p>	<p>The numbered smoke zones</p> <ol style="list-style-type: none"> 1. Reset higher priority than break glass unit (Line A) – see <i>explanation and table below</i> 2. Buzzer active during alarm 3. Controlled smoke zone <ol style="list-style-type: none"> 6.1 Target smoke zone function (<i>displayed only if one or more smoke zones is/are selected</i>) 4. Error generates alarm 5. Slave 1 of this smoke zone 6. Slave 2 of this smoke zone 7. Slave 3 of this smoke zone 8. Slave 4 of this smoke zone 9. Line B (smoke detector) smoke opening pos. 10. Use comfort commands 11. Use comfort commands from slaves 12. Wind direction speed threshold <p>The appendix contains all the items that can be configured - see appendix for detailed explanation.</p>

Wind direction dependent smoke ventilation

Note that when configuring a Master/Slave system, for Wind direction dependent smoke ventilation, the Master zone must reside in the section which the Weather Station is physically connected to.

Line

Some of the functions refer to 'Line'.

Line A Alarm has the highest priority and Line F Alarm has the lowest priority.

The % value for the lines is configurable for each smoke zone. This is done in 'View all details'. Furthermore, in "View all details"

Line E and Line F can be given the highest priority, this can be used for fireman's override panels.

Line	%	Function	Used for
A	100%	open	break glass unit
B	100%	open	smoke detector (Switzerland: the value is often set to 0%, thus the windows will close when smoke)
C	100%	open	
D	0%	close	
E	100%	open	
F	0%	close	
Reset			if this is selected the chosen function(s) will be reset

Number of smoke detectors to give an alarm:

If it is selected, that the alarm is only triggered when more smoke detectors give alarm, the smoke detectors are to be connected to separate smoke detector – see drawing:

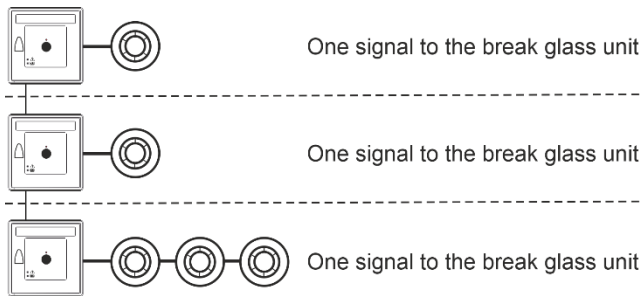

14.6 Local input

The smoke control unit has always two inputs on the WSA 5PS module (input number S1 X2.1 and S1 X2.2).

If further inputs are needed, insert the input/output module WSA 5IO.

This module has eight local inputs.

There can maximum be 26 inputs in a 20A section: 3 input/output modules each with eight inputs as well as the two inputs on the power supply module WSA 5PS.

The touch screen has an overview of the local inputs. Please note that the overview consists of two pages if there are inserted 3 input/output modules.

14.6.1 Numbering of local inputs

All local inputs are numbered.

The number of the input depends on the location of the module - see example below.

Order of modules

The input/output module is as standard inserted in slot 3.

If further modules (input/output and/or motor modules) are added, the input/output modules are inserted before the motor modules.

Examples with local inputs

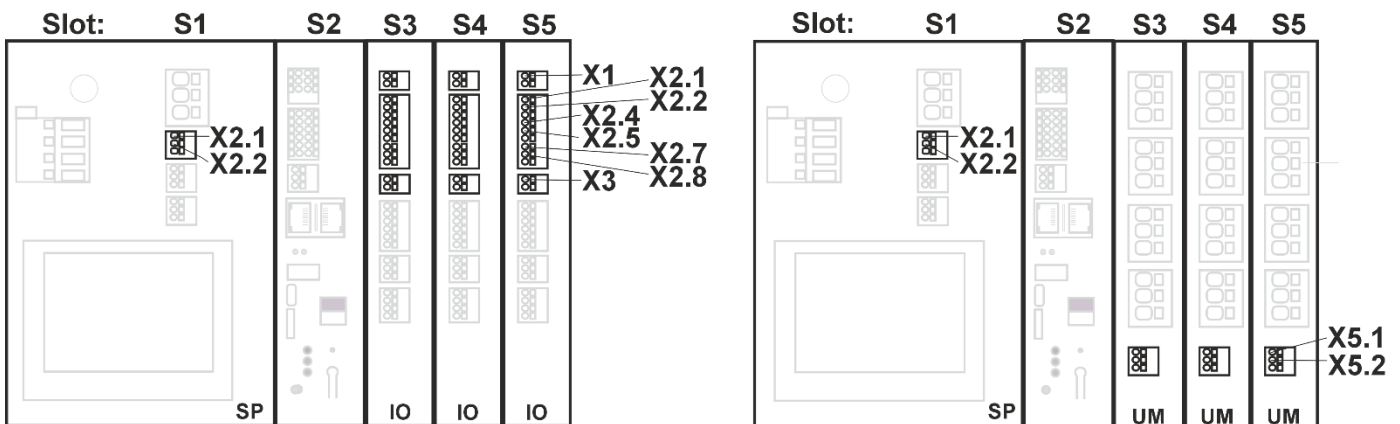

a) Smoke ventilation panel with three Input-/output modules

b) Smoke ventilation panel with three motor modules

14.6.2 Local input - configuration

If component is installed in one or more inputs, these inputs are to be configured.

Which item to be configured depends on the type of input – see description below.

Local input - configuration

Configuration, Local input					
S3 X1	S3 X2.1	S3 X2.2	S3 X2.4	S3 X2.5	S3 X2.7
S3 X2.8	S3 X3	S4 X5.1	S4 X5.2	S5 X5.1	S5 X5.2
S1 X2.1	S1 X2.2				

Overview 'Local input'

Example of overview 'Local input'

Local inputs are to be configured in:

Configuration, Local input, S3 X1	
Input type	Smoke detector
Control smoke zones	3
Function in controlled smoke zones	-
Inactive function in controlled smoke zones	-
	

Configuration of local input S3 on X1

Input X1 on WSA 5IO (smoke detector)

If a smoke detector is connected in the local input X1 on the WSA 5IO module, it shall be configured in:

1. Input type: informs the type "smoke detector" (*not to be configured*)
2. Control smoke zones
 - 2.1 Function in controlled smoke zones (*displayed only if 'Control smoke zones' is selected*)
 - 2.2 Inactive function in controlled smoke zones

The appendix contains all the items that can be configured - see appendix for detailed explanation.

Configuration, Local input, S3 X2.1	
Input type	Binary
Control smoke zones	3
Function in controlled smoke zones	Line B
Inactive function in controlled smoke zones	Comfort open
	

Configuration of local input X2 and X5

Input X2 on WSA 5IO and X5 on WSA 5UM (binary)

If the local inputs on WSA 5IO and/or WSA 5UM are being used, it/they shall be configured in:

1. Input type: informs the type of the input "Binary" (is not to be configured)
2. Control smoke zones*
 - 2.1 Function in controlled smoke zones (*displayed only if 'Control smoke zones' is selected*)
 - 2.2 Inactive function in controlled smoke zones
3. Control motor groups*
 - 3.1 Function in controlled motor groups
 - 3.2 Inactive function in controlled motor groups.

* The input can either control smoke zones or motor groups. When one is selected the other option will disappear from the touch screen.

The appendix contains all the items that can be configured - see appendix for detailed explanation.

Configuration, Local input, S3 X3	
Input type	24/48V
Control smoke zones	-
Active state	On

Configuration of local input X3 on the WSA 5IO module

Input X3 on WSA 5IO (24V/48V) (primary used in France)

If there is connection in X3 on the module WSA 5IO, it shall be configured in:

1. Input type informs the type "24/48V" (*not to be configured*)
2. Control smoke zones
 - 2.1 Function in controlled smoke zones (*displayed only if 'Control smoke zones' is selected*)
3. Active state

The appendix contains all the items that can be configured - see appendix for detailed explanation.

14.6.3 Usage of wind/rain sensors - WLA 33x

Usage of wind/rain sensors WLA 33x with motor groups (MG):

Configuration, Local input, S1 X2.2

Input type Binary

Control motor groups 1 3

Active function in controlled motor groups Safety

Inactive function in controlled motor groups -

The used input e.g., S1X2.2 is configured to “Control motor groups”, the groups are chosen. Then, in the menu “Active function in controlled motor groups” the function “Safety” is selected. Then, the “Inactive function” is selected, which is the function the input applies to the associated motor groups when it becomes inactive.

By each motor group it is possible to define the max opening for “Safety”, meaning it is possible to allow windows and louvers inside the building to open despite “Safety” (wind/rain).

Facade windows, which are allowed to open e.g., 10%, to open despite it rains.

Input shall be configured in:

Configuration, Local input, S3 X2.1: Active function in controlled motor

-	Open
Close	Stop
Safety	Comfort open
Comfort step	Auto. position

Configuration of local input

1. In the motor groups configure the input with the function “Safety”.
2. Configure the motor groups when anything else than close (0%) is desired.

Usage of wind/rain sensors WLA 33x with smoke zones (SZ):

Configuration, Local input, S1 X2.2

Input type Binary

Control smoke zones 1

Function in controlled smoke zones -

Inactive function in controlled smoke zones -

The used input e.g., S1X2.2 is configured as “Control smoke zones” with the function “Comfort safety”

When an input is configured as “Smoke zones” and “Comfort safety” has been selected, there must in the configuration of all the motor groups be selected “Yes” to “Use ‘safety’ from smoke zone”.

Standard setting is “Yes”

If there in the configuration of the smoke zone has been chosen a slave-smoke zone, safety information is automatically transmitted to the slave smoke zone.

Input shall be configured in:

Configuration, Local input, S1 X2.2: Function in controlled smoke zones

-	Line A	Line B	Reset
Line C	Line D	Line E	Line F
Comfort stop	Comfort open	Comfort close	Comfort safety

Configure the input with “Comfort safety” as “Function in controlled smoke zones”.

<div style="border: 1px solid black; padding: 5px;"> <div style="display: flex; align-items: center;"> <input checked="" type="checkbox"/> Configuration, Motor group, no. 1 </div> <div style="margin-top: 10px;"> <div style="display: flex; justify-content: space-between; border-bottom: 1px solid black; padding-bottom: 2px;"> Controlling smoke zone - </div> <div style="display: flex; justify-content: space-between; border-bottom: 1px solid black; padding-bottom: 2px; margin-top: 5px;"> Comfort open position 15% </div> <div style="display: flex; justify-content: space-between; border-bottom: 1px solid black; padding-bottom: 2px; margin-top: 5px;"> Comfort open close time 0 s </div> <div style="display: flex; justify-content: space-between; border-bottom: 1px solid black; padding-bottom: 2px; margin-top: 5px;"> Use 'safety' from smoke zone Yes </div> <div style="display: flex; justify-content: space-between; margin-top: 10px;"> </div> </div> </div>	<ol style="list-style-type: none"> 1. Configure the motor groups to "Use 'safety' from smoke zone" = Yes. 2. Configure if needed also the motor groups in the slave zones with "Use 'safety' from smoke zone" = Yes.
---	--

14.7 Local output

On the WSA 5PS module the smoke ventilation panel has always one output for fault signal (not configurable output).

If further outputs are needed insert an input/output module type WSA 5IO which has four local outputs.

The max number of outputs in a 20A section is 13: 3 input/output modules each with four outputs and the output on the power supply module WSA 5PS.

14.7.1 Numbering of local output

All local outputs on the input/output module are numbered.

The number of the output depends on the location of the module - see example below.

As the output (fault signal) on the WSA 5PS module cannot be configured it is not numbered.

Order of modules

The input/output module is as standard inserted in slot 3 and if further modules (IO and/or motor modules) are added, the IO module is inserted before the motor module.

Example

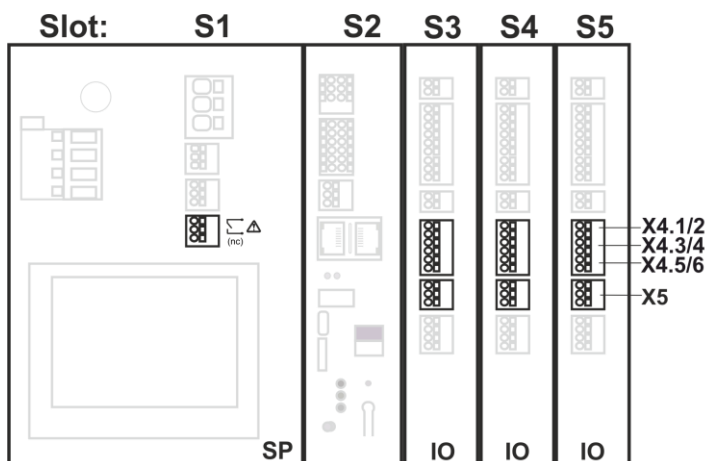

Example: Smoke ventilation panel with 3 x IO modules

14.7.2 Local output - configuration

If component are installed in one or more outputs, these outputs are to be configured.

Which item to be configured depends on the type of output – see description below.

Local output - overview									
<div style="border: 1px solid black; padding: 5px;"> <div style="display: flex; align-items: center;"> <input checked="" type="checkbox"/> Configuration, Local output </div> <div style="margin-top: 10px;"> <table border="1" style="width: 100%; text-align: center; border-collapse: collapse;"> <tr> <td style="width: 25%;">S3</td> <td style="width: 25%;">S3</td> <td style="width: 25%;">S3</td> <td style="width: 25%;">S3</td> </tr> <tr> <td>X4.1/2</td> <td>X4.3/4</td> <td>X4.5/6</td> <td>X5</td> </tr> </table> </div> <div style="margin-top: 10px; text-align: center;"> </div> </div>	S3	S3	S3	S3	X4.1/2	X4.3/4	X4.5/6	X5	<p>Overview 'Local output'</p>
S3	S3	S3	S3						
X4.1/2	X4.3/4	X4.5/6	X5						

Local output shall be configured in:

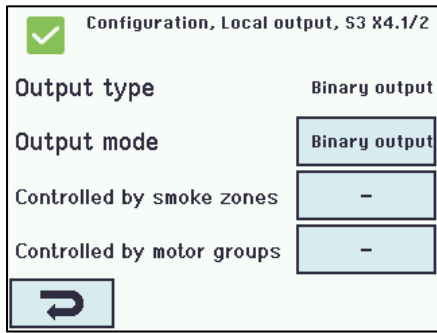

Configuration of at local output (shown for S3 X4.1/2)

1. Output type: informs the type 'Binary output' (is *not* to be configured)
2. Output mode
 - 2.1 Controlled by smoke zones (*displayed only when 'Siren' is selected*)
 - 2.2 Time out
 - 2.3 Smoke zones output functions
3. Controlled by smoke zones* (*displayed only when 'output mode is selected to 'Binary output'*)
 - 3.1 Smoke zone output functions
 - 3.2 Logic function
 - 3.3 Status when active
 - 3.4 Time out
4. Controlled by motor groups
 - a) Motor group output function
 - b) Logic function
 - c) Status when active
 - d) Time-out

* The output can either control smoke zones or motor groups. When one is selected the other option will disappear from the touch screen.

The appendix contains all the items that can be configured - see appendix for detailed explanation.

14.8 Weather station type

Here is to be selected which type of weather station – none, WOW or WLA – that is connected.

The menu “Weather station” is only used for input from WSA 5MC input S2X3.2. If WLA 340 is selected a wind speed (pulse) signal is received from the WLA 340. If WOW is selected a wind speed and wind direction (serial communication) signal is received from WOW 201/202 or WOW 600. See section 10.2 in the installation instruction).

WLA 33x is not a weather station and is connected directly to an input, see section 14.6.3.

Weather station - configuration

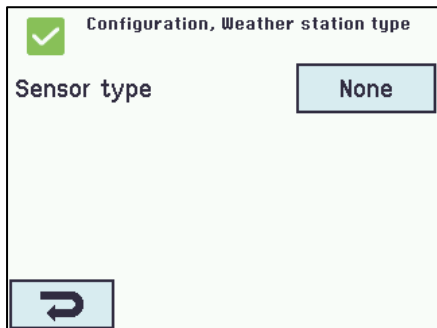

Overview 'Sensor type'

Overview 'Sensor type' (selection of type of weather station)

Weather station shall be configured in:

Configuration, Weather station type :
Sensor type

None <input checked="" type="checkbox"/>	WOW
WLA 340	WOW 600

Configuration of the sensor

None
(no configuration)

- WOW**
1. Filter constant
 2. Slow filter constant
 3. Use RMS in filter
 4. Retransmit time

- WLA**
1. Pulses/sec. per m/s
 2. Filter constant
 3. Slow filter constant
 4. Use RMS in filter
 5. Retransmit time

- WOW 600**
1. Filter constant
 2. Slow filter constant
 3. Use RMS in filter

The appendix contains all the items that can be configured - see appendix for detailed explanation.

14.9 Sequence control

The sequence control functionality is used where the movement of a motor line must depend on an external event or situation/stage. To be used where window flabs are overlapping or where the windows cannot open (e.g. more than 15%) if the blinds are down a.s.o.

The sequence control can be controlled depending on;

- the position of a different motor line
- the state of a local input
- the state of a KNX object
- the state of a BACnet object

Sequence control configuration

Configuration, Motor line, S4 X2

Max. unexpected overcurrent

Max. unexpected overcurrent (motor)

Sequential control type

Activation of sequence control

The activation of sequence control is to be done for each motor line.

Configuration, Motor line, S4 X2:
Sequential control type

None	Open <input checked="" type="checkbox"/>
Close	

Sequence control configuration

The function for the sequence control is to be configured for each motor line

1. **None** - This motor line does not use sequence control
2. **Open** - This motor line must wait for a "result" before opening
3. **Close** - This motor line must wait for a "result" before closing

Sequence control configuration – motor line	
	<ol style="list-style-type: none"> Max. unexpected overcurrent This is not a sequence control parameter Max. unexpected overcurrent (motor) This is not a sequence control parameter Sequential control type This motor line must wait for a „result“ before opening. Sequential control position limit the max position the motor line is allowed to have without the „result“ is being fulfilled. For MotorLink® motor lines stepless variable. For ±24 Volt motor lines 0 or 100%
	<ol style="list-style-type: none"> Sequential control with Select the object the motor line is to wait upon. Choose among another motor line, KNX-, BACnet-, local input or delay timer.
	<ol style="list-style-type: none"> Sequential control with Upon which Motor line, KNX-, BACnet- or local input must the motor line wait. Sequential control with no. Upon which Motor line, KNX-, BACnet- or local input must the motor line wait. Sequential control invert No: waits for a close signal (active input) Yes: waits for an open signal (inactive input) Sequential control max. wait time set the max wait time the motor line should wait, e.g. 60sec. the motor line will then e.g. opens after 60 seconds even when the input condition is not fulfilled. Values between 0 and 64,000 seconds are valid, both for comfort and smoke ventilation. When set to 0 the motor line waits for ever.
	<ol style="list-style-type: none"> Sequential control with Delay timer The motor line is set to wait for a certain period of time 'Sequential control max. wait time'. When the wait time has elapsed the motor line will then move.

14.10 Magnetic clamp (magnetic door retainer)

Motor lines can be defined as magnetic clamps.

Per section up to max. 6A can be used for magnetic clamps, the remaining 14A are reserved for motors.

If a motor line is defined as magnetic clamp there will be power on the output as long as the panel is not triggered in fire condition.

Note, in case of mains power failure, the motor line will also lose its power and the magnetic clamp will release the door.

If a motor line is defined as a magnetic clamp there will be no need of cable monitoring, as a cable error will have the same function as fire condition. The cable monitoring can be selected if an error on the cables is to be shown.

Technical data:

- Power consumption per magnetic clamp: minimum 5mA
- Current per section for magnetic clamp: maximum 6A

FlexiSmoke™ is tested with Hekatron THM 425-1.

Technical data (of Hekatron):

Technische Daten/Caractéristiques techniques/Technical data

24 V DC	Betriebsnennspannung	Tension nominale de service	Nominal operating voltage
63 mA	Stromaufnahme	Intensité du courant d'utilisation	Current consumption
1,5 W	Leistungsaufnahme	Puissance absorbée	Power consumption
1372 N	Haftkraft	Force d'attraction	Holding force
100 %	Einschaltdauer	Régime permanent	Continuous rating
0 bis/jusque/to +50 °C	Betriebsumgebungstemperatur	Température ambiante de service	Ambient operating temperature
IP 40	Schutzart	Type de protection	Ingress protection
1,0 kg	Gewicht	Poids	Weight

Configuration of magnetic clamp

<div style="border: 1px solid black; padding: 5px;"> <p><input checked="" type="checkbox"/> Configuration, Motor line, S5 X1: Motor configuration</p> <table border="1" style="width: 100%; border-collapse: collapse;"> <tr> <td style="width: 50%; text-align: center;">None</td> <td style="width: 50%; text-align: center;">No cable monitoring</td> </tr> <tr> <td style="text-align: center;">3 wire cable monitoring</td> <td style="text-align: center;">Magnetic clamp <input checked="" type="checkbox"/></td> </tr> <tr> <td style="text-align: center;">Magnetic clamp, 3 w. surveillance</td> <td style="text-align: center;">Not set</td> </tr> <tr> <td colspan="2" style="text-align: center;">Pyrotechnic gas generator</td> </tr> <tr> <td style="text-align: center;"><input checked="" type="checkbox"/></td> <td style="text-align: center;"><input checked="" type="checkbox"/></td> </tr> </table> <p style="text-align: center;">Configuration of magnetic clamp</p> </div>	None	No cable monitoring	3 wire cable monitoring	Magnetic clamp <input checked="" type="checkbox"/>	Magnetic clamp, 3 w. surveillance	Not set	Pyrotechnic gas generator		<input checked="" type="checkbox"/>	<input checked="" type="checkbox"/>	<p>The configuration of magnetic clamp must be done for each motor line.</p> <p>Under the configuration of Motors line Magnetic clamp.</p>
None	No cable monitoring										
3 wire cable monitoring	Magnetic clamp <input checked="" type="checkbox"/>										
Magnetic clamp, 3 w. surveillance	Not set										
Pyrotechnic gas generator											
<input checked="" type="checkbox"/>	<input checked="" type="checkbox"/>										
<div style="border: 1px solid black; padding: 5px;"> <p><input checked="" type="checkbox"/> Configuration, Motor line, S5 X1</p> <p>Motor type: ±24V motor</p> <p>Motor configuration: <input type="text" value="Magnetic clamp"/></p> <p>Motor group: <input type="text" value="1"/></p> <p>Manual command – auto. off period: <input type="text" value="30 min."/></p> <p style="text-align: center;"> <input type="button" value="↶"/> <input type="button" value="↓"/> </p> <p style="text-align: center;">Konfigurierung af Holdemagnet - ±24V motor</p> </div>	<p>Each motor line (±24V motor) which is configured as a magnetic clamp must be associated with a motor group.</p>										
<div style="border: 1px solid black; padding: 5px;"> <p><input checked="" type="checkbox"/> Configuration, Motor line, S4 X3</p> <p>Motor type: MotorLink™</p> <p>Expected no. of motors: <input type="text" value="Magnetic clamp"/></p> <p>Motor group: <input type="text" value="-"/></p> <p>Manual command – auto. off period: <input type="text" value="30 min."/></p> <p style="text-align: center;"> <input type="button" value="↶"/> <input type="button" value="↓"/> </p> <p style="text-align: center;">Konfigurierung af Holdemagnet - MotorLink® motor</p> </div>	<p>Each motor line (MotorLink®) which is configured as a magnetic clamp must be associated with a motor group.</p>										

14.11 Pyrotechnic gas generator

A pyrotechnic gas generator is a pyrotechnic detonator, which is now supported on the ±24 Volt motor line outputs on the WSA 5PS and WSA 5MS modules.

Typical data:

- Resistor: 1.4 to 1.6 Ohm
- 100% no ignition: 180 mA / 5 min. DC
- 100% ignition: 600 mA / 10 ms (DC)
- Test current: max: 10 mA

FlexiSmoke™ is tested with Chemring Typ 1.3.

Configuration of pyrotechnic gas generator

<input checked="" type="checkbox"/> Configuration, Motor line, S5 X1: Motor configuration	
None	No cable monitoring
3 wire cable monitoring	Magnetic clamp
Magnetic clamp, 3 w. surveillance	Not set
Pyrotechnic gas generator <input checked="" type="checkbox"/>	
<input checked="" type="checkbox"/>	<input checked="" type="checkbox"/>

Configuration of pyrotechnic gas generator

The configuration of pyrotechnic gas generators must be done for each motor line.

When a motor line is configured as pyrotechnic gas generator:

- it will not react on comfort commands
- the cable monitoring will detect cable interruption
- NO end of line motor modules (WSA 432 / 510) is to be inserted
- motor line must be configured as pyrotechnic gas generator BEFORE the generator is connected!

When more pyrotechnic gas generators are to be connected on the same motor line, they (max. 5 pcs) are to be connected in series.

For dimensioning of cable see section 8.3.3.

14.12 Alarm output

A motor output can be configured as "Alarm output" for operating an external DC relay. The output becomes active according to the motor group configuration.

Recommended relay:

Finder type 40.52.9.028.000 (28V, not sensitive), coil impedance 1.2kΩ or similar.

The relay is connected to output S1, X1/X2/X3/X4 on the standard motor card.

Cable monitoring is possible. For full monitoring of all cables, the end of line motor module (WSA 510) is recommended.

Alarm output shall be configured in:

<input checked="" type="checkbox"/> Configuration, Motor line, S5 X1: Motor configuration	
None	No cable monitoring
3 wire cable monitoring	Magnetic clamp
Magnetic clamp, 3 w. surveillance	Not set
Pyrotechnic gas generator	Alarm output <input checked="" type="checkbox"/>
<input checked="" type="checkbox"/>	<input checked="" type="checkbox"/>

Configuration of alarm output

The configuration of alarm output must be done for each motor line.

<input checked="" type="checkbox"/> Configuration, Motor line, S5 X1: Wire cable check type	
Diodes (WSA 432)	10k0hm resistors (WSA 510)
10k0hm resistors, simple (WSA 510)	None
<input checked="" type="checkbox"/>	<input checked="" type="checkbox"/>

Configuration of cable monitoring

The configuration of cable monitoring must be done for each motor line.

Connection of relay

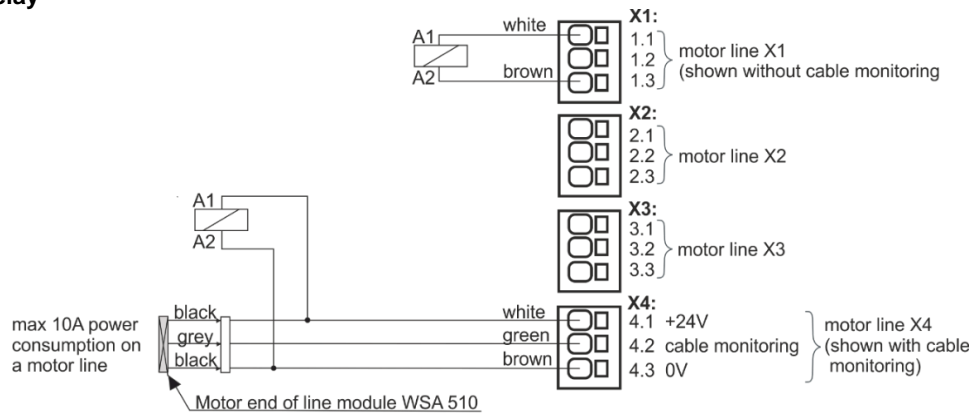

14.13 CAN bus

The CAN bus is used for master/slave connections of smoke zones in multiple sections.

Up to 31 sections of the FlexiSmoke™ smoke ventilation panel can be connected via CAN bus.

FlexiSmoke™ uses a special communication format, so the CAN bus from a FlexiSmoke™ must not be connected to other systems with CAN.

IMPORTANT

Each section that is connected with CAN shall for correct function be assigned with a unique 5MC ID.

This configuration shall be done during commissioning or when replacing a WSA 5MC module in one or more sections. This configuration is done under the menu item CAN.

In applications where redundancy is required (to be sure an error in one smoke zone does not affect the function of another smoke zone), both the CAN 1 and CAN 2 shall be connected between the smoke ventilation panels/sections. The sections in a FlexiSmoke™ smoke ventilation panel are, when delivered from factory, connected with both CAN.

If there is no need for redundancy, only a single CAN bus can be connected. When only a single CAN bus is used, the CAN bus mode must be set to "Independent buses", and the bus in use must be selected. In example below, CAN 1 is used.

The configuration is done in the sub menu: „Configuration → CAN → All.

It is not recommended to change the CAN-speed, which is factory set to 10 kbps.

Appendix contains all items that can be configured, see the appendix for detailed explanation.

The item "Operate other WSA 5MC module" in main menu on the touch screen allows to operate all sections that are connected via the CAN bus (see chapter 18). Even if there is no need to establish master/slave connection between several FlexiSmoke™ smoke ventilation panels, the option for remote control will often be of major benefit when commissioning and maintenance. If the CAN is only used for commissioning and maintenance, there is only need for a single bus connection.

CAN bus shall be configured in:

Configuration, CAN

MC ID

CAN bus mode

Configuration of 'Parallel bus'

1. 5MC-ID
2. CAN bus mode = Parallel bus

The appendix contains all the items that can be configured - see appendix for detailed explanation.

Configuration, CAN

MC ID

CAN bus mode

CAN 1 in use

CAN 2 in use

Configuration of 'Independent buses'

1. CAN bus mode = Independent buses
2. CAN 1 in use = yes

Master/slave connection of smoke zones

A smoke zone can be master for up to 4 other smoke zones. Master/slave connections can be established hierarchically. A slave-smoke zone can only be connected to one master.

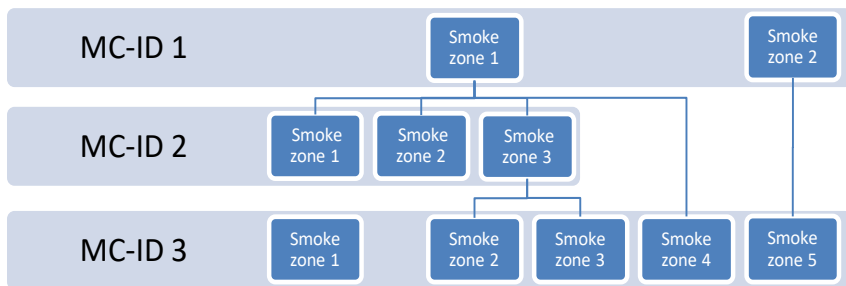

Break glass units and input assigned to a slave-smoke zone are automatically sent to the master smoke zone. They are in the evaluation of smoke on equal level as the local input on the master. The master sends the smoke commands to slaves, which only receive input from the master. To get the fastest response, it is recommended that break glass units are assigned to the section in which the master belongs.

When a smoke area (several smoke zones connected in a master-slave relation) consists of more sections and/or more master-slave levels, it is necessary to press the re-set button on the break glass unit for 5-10 sec to ensure that the close command reaches all sections in the smoke zone.

A smoke zone (master or slave) can be configured to react / not react on associated keypads.

A smoke zone can be configured to react / ignore comfort commands from its slaves. If the smoke zone is configured to ignore comfort commands from its slaves, these signals will not be sent to the Master. This mechanism can be used to establish comfort keypads which e.g., only operate a part of a larger smoke zone.

The configuration of a master/slave is done in the menu "Configuration smoke zone <n>" where each of the up to 4 slaves connections can be selected from the connected and active sections.

14.14 Network

For configuring network addresses

The WSA 5MC module has a 10/100Mbit Ethernet connection. The connection support DHCP or fast IP address as well as Gateway

It is possible to configure different power consumption profiles for the Ethernet connection. To burden the 72 hours back-up batteries as little as possible, use the setting 'Off' or 'Auto' (factory setting).

The appendix contains all the items that can be configured - see appendix for detailed explanation.

Network is used in connection with BACnet IP interface – for further information see the "WSC 5xx Protocol Implementation Conformance Statement (PICS)" on the home pages (www.windowmaster.com).

Network shall be configured in:	
<p>Configuration of 'Network'</p>	<ol style="list-style-type: none"> 1. DHCP 2. Power setting <p>The appendix contains all the items that can be configured - see appendix for detailed explanation.</p>

14.15 Fieldbus

"Module"

The WSA 5MC module is available in different versions with different possible connection of a fieldbus for status and comfort operation.

Note: Smoke ventilation function has higher priority than comfort commands from the field bus and it is recommended only to use field bus for comfort purposes.

Overview for WSA 5MC versions

Version	Type of letter in the item number	BACnet IP support	Field bus, Type, Media
WSA 5MC NCO	0	No	None
WSA 5MC KNX	K	Yes	KNX TP1

14.15.1 KNX-bus

There is a set of KNX objects available for each motor line, motor group and smoke zone, which provides the options for status and commands.

Status options

E.g., actual position, fault and operation status and the max opening angle (degrees).

Command options

E.g., target position commands with different priority and MotorLink® motor speed.

See "KNX Application Program Description " on the home pages (www.windowmaster.com) for further information on available KNX communication objects.

Fieldbus link - "Conn. 1-13 "

The KNX has also 13 configurable binary communication objects.

These can either be used for sending comfort commands to one or more motor groups or to give selected status from smoke zones or motor groups.

KNX bus configuration

<div style="border: 1px solid gray; padding: 5px; margin-bottom: 5px;"> <p style="text-align: center;"><input checked="" type="checkbox"/> Configuration, KNX bus</p> <table border="1" style="width: 100%; border-collapse: collapse; text-align: center;"> <tr> <td style="font-size: small;">Module</td> <td>Obj. 1</td> <td>Obj. 2</td> <td>Obj. 3</td> <td>Obj. 4</td> <td>Obj. 5</td> </tr> <tr> <td></td> <td>Obj. 6</td> <td>Obj. 7</td> <td>Obj. 8</td> <td>Obj. 9</td> <td>Obj. 10</td> </tr> <tr> <td></td> <td>Obj. 11</td> <td>Obj. 12</td> <td>Obj. 13</td> <td></td> <td></td> </tr> </table> <p style="text-align: center; margin-top: 10px;"></p> <p style="text-align: center; font-size: small;">KNX bus overview</p> </div>	Module	Obj. 1	Obj. 2	Obj. 3	Obj. 4	Obj. 5		Obj. 6	Obj. 7	Obj. 8	Obj. 9	Obj. 10		Obj. 11	Obj. 12	Obj. 13			<p>Overview 'KNX bus'</p>
Module	Obj. 1	Obj. 2	Obj. 3	Obj. 4	Obj. 5														
	Obj. 6	Obj. 7	Obj. 8	Obj. 9	Obj. 10														
	Obj. 11	Obj. 12	Obj. 13																
KNX bus shall be configured in:																			
<div style="border: 1px solid gray; padding: 5px; margin-bottom: 5px;"> <p style="text-align: center;"><input checked="" type="checkbox"/> Configuration, KNX bus</p> <p>Module type KNX, no bus or ETS</p> <p>Power setting Off</p> <p style="text-align: center; margin-top: 10px;"></p> <p style="text-align: center; font-size: small;">Configuration of 'KNX bus'</p> </div>	<p>1. Module type 2. Power setting</p> <p>The appendix contains all the items that can be configured - see appendix for detailed explanation.</p>																		

14.15.2 BACnet

There is a set of BACnet objects available for each motor line, motor group and smoke zone, which provides the options for status and commands.

Status options

E.g., actual position, fault and operation status and the max opening angle (degrees).

Command options

E.g., target position commands with different priority and MotorLink® motor speed.

See " WSC 5xx Protocol Implementation Conformance Statement (PICS)" on the home pages (www.windowmaster.com) for further information on available BACnet communication objects.

Fieldbus link - "Conn. 1-13 "

The BACnet has also 13 configurable binary communication objects.

These can either be used for sending comfort commands to one or more motor groups or to give selected status from smoke zones or motor groups.

BACnet configuration																			
<div style="border: 1px solid black; padding: 5px;"> <div style="display: flex; align-items: center;"> <input checked="" type="checkbox"/> Configuration, BACnet </div> <table border="1" style="width: 100%; border-collapse: collapse; margin-top: 5px;"> <tr> <td style="font-size: small;">Com-mon</td> <td style="font-size: small;">Obj. 1</td> <td style="font-size: small;">Obj. 2</td> <td style="font-size: small;">Obj. 3</td> <td style="font-size: small;">Obj. 4</td> <td style="font-size: small;">Obj. 5</td> </tr> <tr> <td style="font-size: small;">Obj. 6</td> <td style="font-size: small;">Obj. 7</td> <td style="font-size: small;">Obj. 8</td> <td style="font-size: small;">Obj. 9</td> <td style="font-size: small;">Obj. 10</td> <td style="font-size: small;">Obj. 11</td> </tr> <tr> <td style="font-size: small;">Obj. 12</td> <td style="font-size: small;">Obj. 13</td> <td colspan="4"></td> </tr> </table> <div style="text-align: center; margin-top: 10px;"> </div> </div> <p style="text-align: center; font-size: small;">BACnet overview</p>	Com-mon	Obj. 1	Obj. 2	Obj. 3	Obj. 4	Obj. 5	Obj. 6	Obj. 7	Obj. 8	Obj. 9	Obj. 10	Obj. 11	Obj. 12	Obj. 13					<p>Overview over BACnet</p>
Com-mon	Obj. 1	Obj. 2	Obj. 3	Obj. 4	Obj. 5														
Obj. 6	Obj. 7	Obj. 8	Obj. 9	Obj. 10	Obj. 11														
Obj. 12	Obj. 13																		
BACnet shall be configured in:																			
<div style="border: 1px solid black; padding: 5px;"> <div style="display: flex; align-items: center;"> <input checked="" type="checkbox"/> Configuration, BACnet </div> <div style="margin-top: 5px;"> <p>BACnet IP UDP port number 47808</p> <p>BACnet IP device instance 1</p> <p>Actual position COV increment 1%</p> <p>Actual max. position COV increment 1%</p> </div> <div style="display: flex; justify-content: space-between; margin-top: 10px;"> <div style="text-align: center;"> </div> <div style="text-align: center;"> </div> </div> </div> <p style="text-align: center; font-size: small;">Configuration of Module</p>	<ol style="list-style-type: none"> 1. BACnet IP UDP port number 2. BACnet IP device instance 3. Actual position COV – increment 4. Actual max. position COV- increment <p>The appendix contains all the items that can be configured - see appendix for detailed explanation.</p>																		

14.16 Configuration files on SD

The panel has a plug in for micro SD card.

The card is used for log file and back up of the configuration of the panel. The card should NOT be removed.

It is possible to save all the configurations of the panel and this way save the card as documentation.

It is also possible to reinstall from the SD card or to copy to an USB stick.

Copying to/from the SD card is to be done section by section – meaning that there are to be made 3 savings for a WSC 560.

The SD card's file names are numbered from 1 to 24.

Files on the card can be transferred to a spread sheet (Excel).

Configuration files on SD																									
<div style="border: 1px solid black; padding: 5px;"> <div style="display: flex; align-items: center;"> <input checked="" type="checkbox"/> Configuration, Configuration files, SD </div> <table border="1" style="width: 100%; border-collapse: collapse; margin-top: 5px;"> <tr><td style="font-size: small;">1</td><td style="font-size: small;">2</td><td style="font-size: small;">3</td><td style="font-size: small;">4</td><td style="font-size: small;">5</td><td style="font-size: small;">6</td></tr> <tr><td style="font-size: small;">7</td><td style="font-size: small;">8</td><td style="font-size: small;">9</td><td style="font-size: small;">10</td><td style="font-size: small;">11</td><td style="font-size: small;">12</td></tr> <tr><td style="font-size: small;">13</td><td style="font-size: small;">14</td><td style="font-size: small;">15</td><td style="font-size: small;">16</td><td style="font-size: small;">17</td><td style="font-size: small;">18</td></tr> <tr><td style="font-size: small;">19</td><td style="font-size: small;">20</td><td style="font-size: small;">21</td><td style="font-size: small;">22</td><td style="font-size: small;">23</td><td style="font-size: small;">24</td></tr> </table> <div style="text-align: center; margin-top: 10px;"> </div> </div> <p style="text-align: center; font-size: small;">Configuration files on SD overview.</p>	1	2	3	4	5	6	7	8	9	10	11	12	13	14	15	16	17	18	19	20	21	22	23	24	<p>Configuration files on SD overview.</p>
1	2	3	4	5	6																				
7	8	9	10	11	12																				
13	14	15	16	17	18																				
19	20	21	22	23	24																				

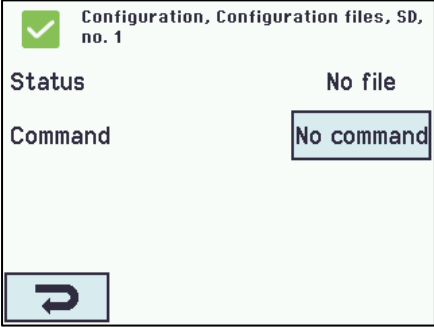
 <p>Configuration of configurations file on SD – no.1</p>	<p>Configuration of configurations file on SD – shown for no.1</p>
--	--

14.17 Configuration files on USB

The panel has a plug in for an USB stick. It is possible to save all the configurations of the panel and this way save the stick as documentation. It is also possible to reinstall from the USB stick.

Copying to/from the USB stick is to be done section by section – meaning that there are to be made 3 savings for a WSC 560. The USB stick's file names are numbered from 1 to 24. Files on the USB stick can be printed from a computer.

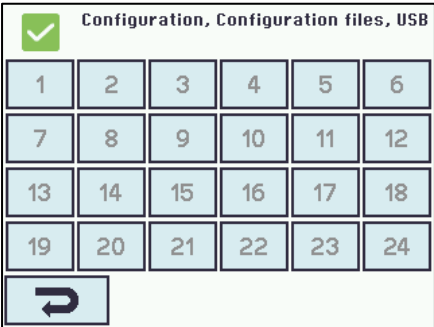
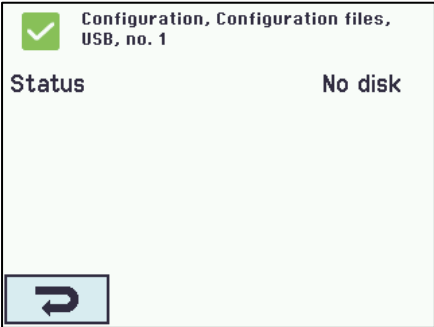
 <p>Configuration 'Configuration, files on USB' – overview</p>	<p>Configuration files on USB – overview.</p>
 <p>Configuration of 'Configuration files on USB – no. 1'.</p>	<p>Configuration of configuration files on USB – shown for no. 1.</p>

14.18 System

It is possible to change settings on the touch screen e.g., language, clock setting, date display, service timer etc.

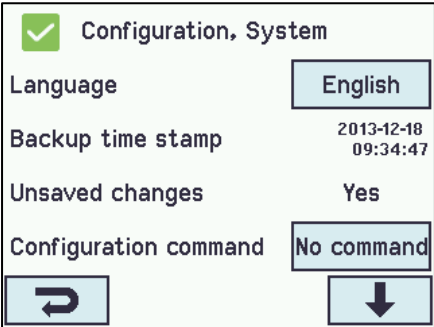
System can be configured in:	
 <p>Configuration of 'System'</p>	<ol style="list-style-type: none"> 1. Language 2. Backup time stamp (<i>not to be configured</i>) 3. Unsaved changes... (<i>not to be configured</i>) 4. Configuration command 5. Copy log 6. Time 7. Date 8. Reset service timer 9. The interval between service 10. LCD rotate view 11. Enable parameter set from network 12. Enable remote control <p>The appendix contains all the items that can be configured - see appendix for detailed explanation.</p>

14.18.1 Service timer

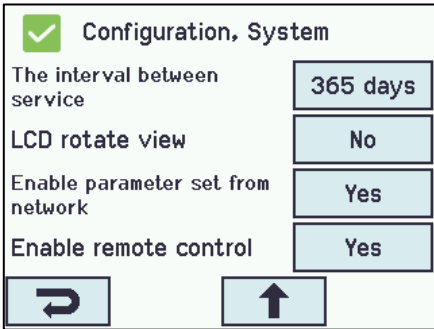
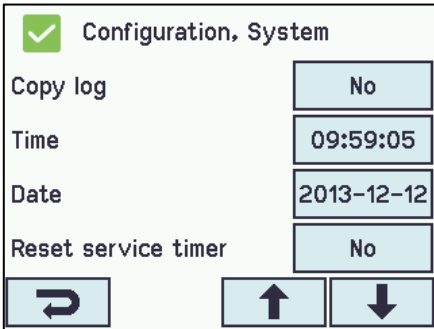
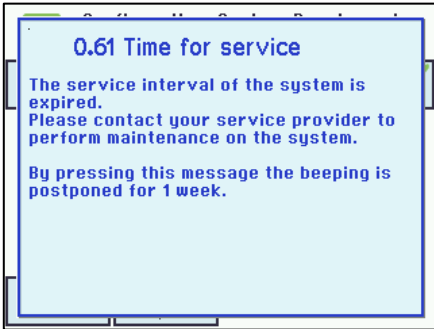
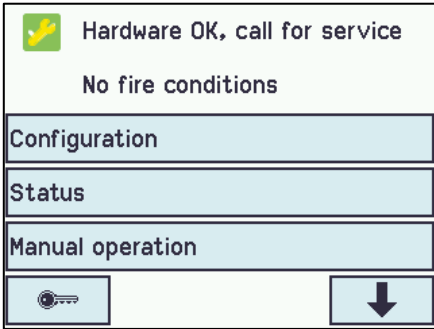
Configuration of interval between maintenance:	
 <p>Configuration of interval between service</p>	<p>The timer is set in “days until the next maintenance”. Typically, on most markets, this will be 365 days.</p> <p>If the interval between maintenances is set to 0, the timer is disabled.</p> <p>The acoustic notification can be activated or deactivated under “View all details”</p>
 <p>Reset off service timer</p>	<p>”Reset service timer” set the last maintenance date as today.</p>
 <p>Message when the service timer expires</p>	<p>When the service timer expires the touch screen will show a maintenance text and a clear beeping will sound from the panel.</p>
 <p>Main overview when the service timer has been postponed</p>	<p>If you confirm the service timer by touching the touch screen, it will be mute for a week, before the beeping sound starts again.</p> <p>A maintenance icon will appear on the touch screen.</p>

15 Status – main menu

In 'Status' you can see the status of all the menu items that can be configured under 'Configuration' as well as the status of the power supply (including mains and battery status) and slots (inform the type of module in the slot).

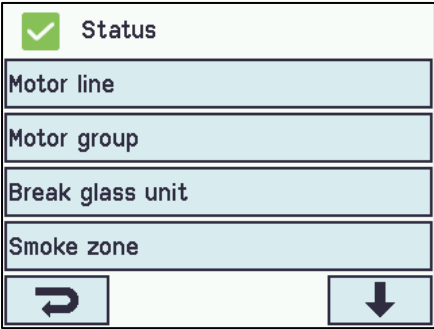

Main overview: status of the system

Under 'Status' is possible to view the status for:

1. Motor line
2. Motor group
3. Break glass unit
4. Smoke zone
5. Local input
6. Local output
7. Weather station type
8. Power supply
9. CAN (local)
10. Ethernet
11. Slots
12. KNX Bus
13. System

It is not possible to configure the items in 'Status' mode.
The appendix contains all the items shown in 'Status' - see appendix for detailed explanation.

16 Manual operation – main menu

It is possible to operate the motor lines, the motor groups and the smoke zones direct on the touch screen.

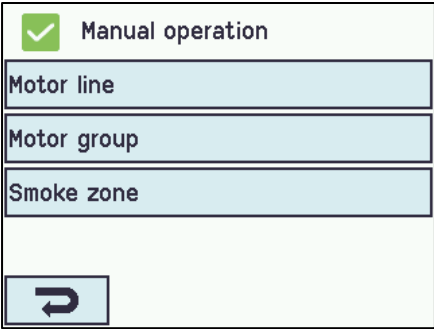

Main overview: manual operation

What to be manually operated:

1. Motor line – see text below
2. Motor group
3. Smoke zone

Operation types

Motor lines and motor groups

They can be operated **absolutely** (percentage of full open) or **relatively** on the keypad 'open/stop/close' showed on the touch screen.

Smoke zones

They can be operated in 'Alarm' or 'Reset'

Example

Manual operation of a motor line

- If 'All' is selected all the motors are operated simultaneously.
- If a motor line number is selected only the selected motor line is operated.

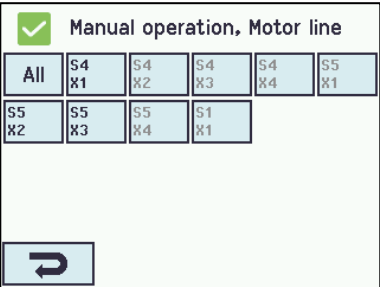

Motor line - overview

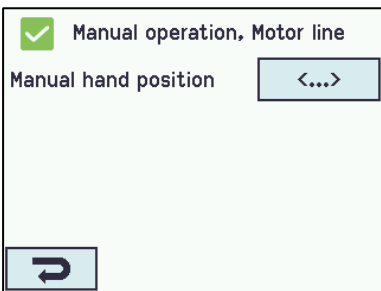

One motor line is selected

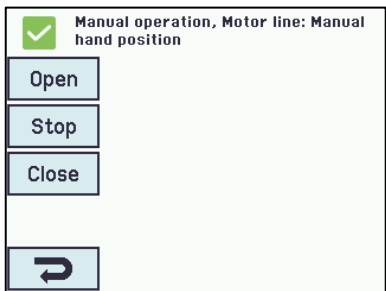

Manual operation on the touch screen

17 Configuration missing – main menu

If any components, motor lines, motor groups or smoke zones are not configured they are listed here.

If you are logged into access level 4 it is also possible to configure from this menu.

18 Hardware error – main menu

If there are any hardware error in a section, they will be displayed here.

E.g. if the motor lines are not configured, the main supply is cut of, the back-up batteries are not connected, the type of weather station is not selected etc.





If you are logged into access level 4 it is also possible to configure from this menu.

18.1 Error on the Power supply

Mains power failure will trigger an error on the "Power supply". The first 10 minutes (parameter setting) after the failure has been detected, no error is indicated neither on the panel, the display nor in the break glass units.

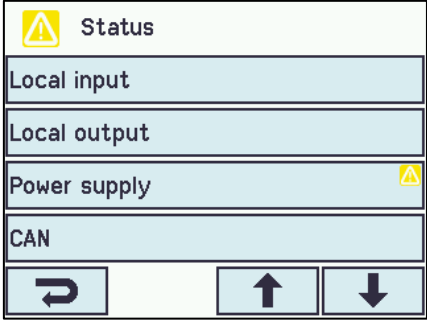
The following 20 minutes the error will be indicated as a warning meaning the green LED on the break glass units will flash, on the WSA-5MC module the green LED is still on, and the yellow LED is turned off. 30 minutes after the mains power failure has been detected all the green LED will turn off and the all the yellow LEDs in the smoke ventilation panel and the break glass units will lit continuously.

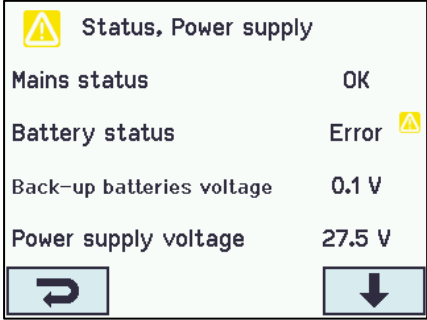
Furthermore, non connected, wrong connected or "dead" batteries can trigger an error on the "Power supply".

 <p>Status</p> <p>Local input</p> <p>Local output</p> <p>Power supply </p> <p>CAN</p> <p>Navigation buttons: Back, Up, Down</p>	 <p>Status, Power supply</p> <p>Mains status OK</p> <p>Battery status Error </p> <p>Back-up batteries voltage 0.1 V</p> <p>Power supply voltage 27.5 V</p> <p>Navigation buttons: Back, Down</p>
Error on the power supply	Error on the Battery status

18.1.1 Blown fuse – 20A fast

Additionally, an error on the "Battery status" can also be triggered if the fuse (20A fast) is blown.

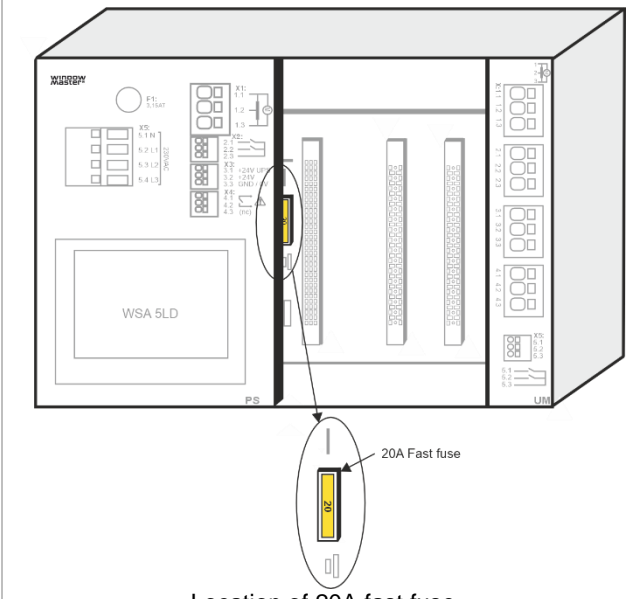
 <p>Diagram showing the internal components of the device. A 20A Fast fuse is highlighted with a red circle and labeled. The fuse is located behind the modules. The diagram also shows the WSA 5LD module, PS, and UIM components.</p> <p>Location of 20A fast fuse</p>	<p>The fuse is located behind the modules. To replace the fuse, it is therefore necessary to remove the modules, see section 23.2 for replacement of modules.</p>
--	---

18.1.2 Blown fuse – 3.15A slow

If there seems to be no sign of function in the smoke panel AND the green LED is not working either, it can be caused by a blown 3.15A slow fuse. The fuse is only blown if the green LED does not shine.

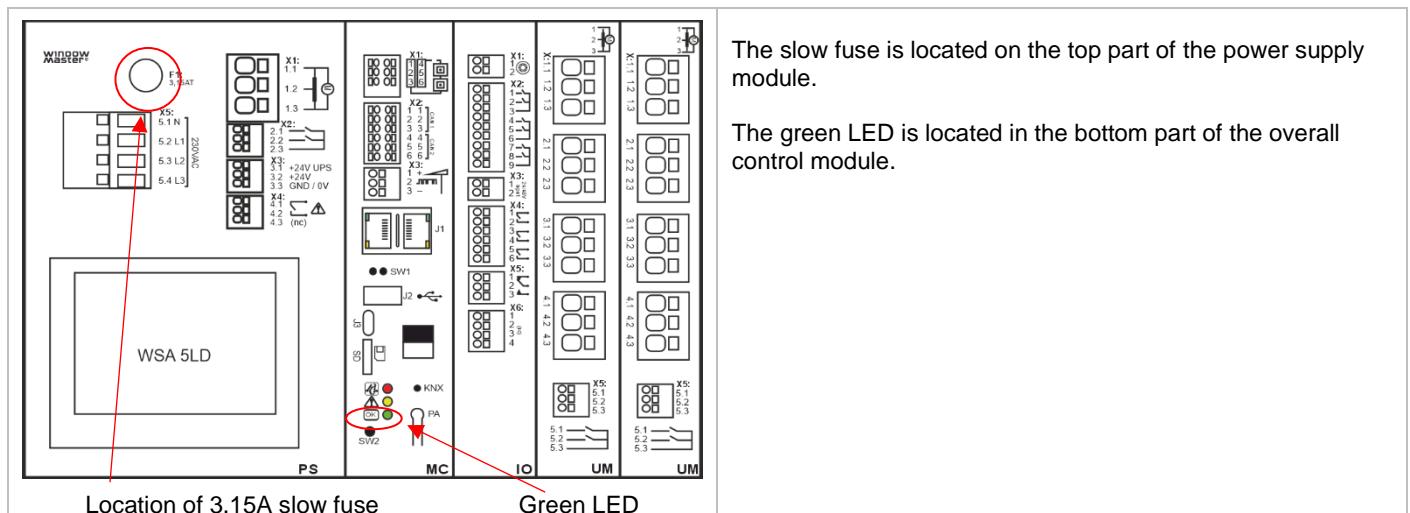

The slow fuse is located on the top part of the power supply module.

The green LED is located in the bottom part of the overall control module.

Both fuses are common fuses and can be purchased in by distributors of electronics.

19 Manage another WSA MC module – main menu

It is possible to operate more sections (up to 31 sections) from the same touch screen. The function is used if the operation of several sections in one panel (WSC 540 or WSC 560) is to be done on the same touch screen or if more panels connected via CAN are to be operated from the same touch screen.

Select the section(s) that is (are) to be operated from this touch screen.

The touch screen changes to green when you operate another selected section.

To return to the master touch screen: press  or press the number of the master touch screen.

You can still/also operate the sections on their own touch panels.

20 View all details – main menu

To make the configuration of the smoke ventilation panel as simple as possible during configuration (see chapter 13), it is only possible to configure the most used functions.

Under 'View all details' is displayed all of the above functions together with detailed functions that are not used as often but are possible to configure.

If you are logged into access level 4 it is also possible to configure from this menu.

It is possible to view all details for:

- Motor line
- Motor group
- Break glass unit
- Smoke zone
- Local input
- Local output
- Weather station type
- Power supply
- CAN
- Network
- KNX bus
- BACnet
- Log in
- Configuration files, SD
- Configuration files, USB
- System

21 Remote control of FlexiSmoke™

It is possible to remote control a FlexiSmoke™ from a PC.

When the FlexiSmoke™ is on a standard computer network (Ethernet) you can from any PC with the "WMAFlexiSmokeRemote" program control the FlexiSmoke™ just like if you were standing in front of the panel.

The program "WMAFlexiSmokeRemote" program can be downloaded from our webpages (www.windowmaster.com) under FlexiSmoke™.

Remote control can be configured in:

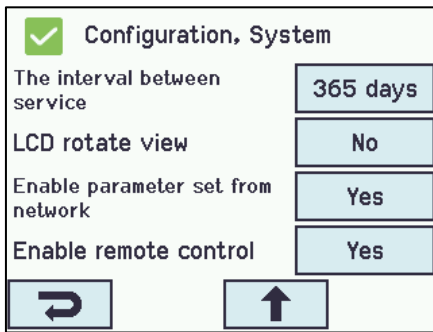

Configuration of remote control

To enable remote control of the panel it is necessary to allow remote control. This is done in the configuration of the system.

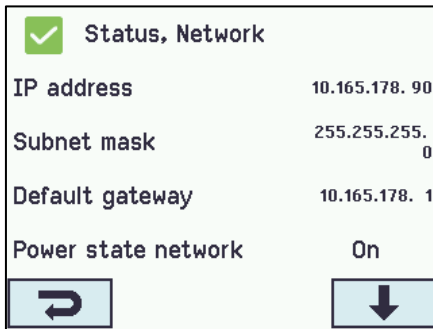

Identification of the IP-address

IP-address of the FlexiSmoke™

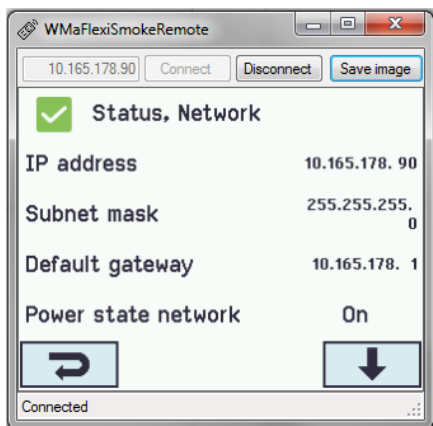

Screen shot from the PC when controlling the FlexiSmoke™ remotely

Start the 'WMaFlexiSmokeRemote' program on the connected PC. Enter the IP-address and press 'Connect'.

22 Commissioning and test run

In case of hardware error please see chapter 17 "The menu 'Hardware error'"

The break glass unit WSK 50x will only give an acoustic fault signal if the door on the break glass unit is closed or if the door contact on the break glass unit is pressed.

We recommend that the software of the panel is updated during the annual maintenance check!

We recommend that the commissioning of the smoke panel should be done by a competent smoke ventilation controls installer.

22.1 The control ventilation panel is completely installed, without the operating voltage applied

- a) Check all mechanical and electrical components for damage.
- b) When more panels are connected via CAN, check the DIP slide switches in the sections in the smoke control panel for their correct (required) position. See section 10.2 – WSA 5MC overall control module.
- c) Check all screw and plug connections for tightness and/or firm seating
- d) Check that all external components are installed:
 - 1) ±24V actuators: Is the motor end module inserted in the last or only actuator?
 - 2) Automatic smoke detectors: Is the passive end module inserted in the last or only smoke detector?

22.2 With mains voltage, without accumulator

Adhere to the relevant regulations! Connect the mains cables and reapply the mains voltage.

22.3 With mains voltage, with accumulator

- a) Connect the accumulators to the black accumulator bridge according to the wiring diagram, then connect the red and the black connection cable to the red and the black flat plug. Insert the batteries in the smoke ventilation panel according to section 11.
- b) Plug the red connection cable to the + and the black connection to the flat plug of the control panel.
Note: Check correct polarity!
- c) The smoke ventilation panel can now be configured as described in chapter 13 "The menu 'Configuration'".

22.4 Ventilation keypad

Closely observe the motors during opening and closing. They must not be impaired in any position by the building structure. Observe that the motor cables are not being subject to pulling or pinching. Check each ventilation keypad individually.

22.5 Break glass unit WSK 50x

- a) Open the door and press the black Open button. The actuators move open through to the end position. The red alarm LED (also in the control panel) is ON; at the same time a permanent acoustic signal sounds (door contact on the break glass unit is pressed!).
- b) Press the Reset/Closed button in the break glass unit. The actuators close through to the end position. The comfort ventilation function is released again. The red alarm LED (also in the smoke ventilation panel) and the acoustic smoke alarm are turned off.

22.6 Smoke detectors

- a) Spray test aerosol on the smoke detectors (aerosol item no. 9549).
- b) The actuators move open through to the end position. The red LED in the smoke detector, the red alarm LED (also in the smoke ventilation panel) and the permanent acoustic signal in the break glass unit are ON.
- c) Press the Reset/Closed button in the break glass unit - the actuators close through to the end position. The comfort ventilation function is released again. The red alarm LED in the break glass unit and in the smoke control panel as well as the acoustic smoke alarm are turned off.

22.7 Emergency power supply test

- a) Remove the mains fuse from each section of the smoke ventilation panel. Wait 10 minutes (or run the motors shortly). See also national guidelines.
- b) When a mains error has occurred the green LED in the break glass units will flash for 10 minutes. The green LED on the WSA 5MC module in the smoke ventilation panel is still on and the yellow LED is turned off.
- c) After 10 minutes the green LEDs will turn off and all the yellow LEDs in the smoke ventilation panel and the break glass units will lit continuously.
- d) The comfort ventilation keypads are deactivated.
- e) Test the SHE trip and reset/closed as described under section 20.5.
- f) Refit the mains fuse.
- g) The green mains and operating LED's are on, the yellow LED is off, the malfunction message at the break glass unit is off.

22.8 Wind/rain detector

- a) Open the actuators with the comfort ventilation keypads.
- b) Wet the rain sensor, the actuators will fully close.
- c) While the actuators are running, press the Open button at the keypad. The actuators must neither open nor stop!
Exception: If set as in point 13.2.3.8 to a manual override time (Man. operation after auto comm.).
- d) The SHE trip has priority.
- e) While the rain sensor is active (wet) the smoke ventilation panel is activated (alarm) and the actuators move open through to the end position (alternatively to the SHE position)

If the start-up was successful, close the doors of the break glass units and of the smoke ventilation panel.

If the start-up was unsuccessful (error with one of the test run processes), please see chapter 10 "Description of modules".

If necessary, check the wiring in accordance with the cable plan – see chapter 9 "Cable plan for connection to WSC 520 / 540 / 560".

23 Maintenance

The panels of the smoke detection and heat extraction system have to be checked, serviced and, if necessary, repaired at least once per year by the manufacturer or an authorized system.

Remove all soiling from the units of the smoke and heat extraction system. Check fastening and clamping screws for firm seating. Carry out a test run of the entire system (see chapter 22 'Commissioning and test run'). Only have defective units repaired in our factory. Only install original spare parts.

Check the operational condition at regular intervals. We recommend a WindowMaster service contract is taken out to ensure the right function of the smoke and heat extraction system.

All back up batteries coming with the smoke control panel as standard; have to be subjected to regular checks.

The smoke ventilation panel will signal fault on the batteries if:

1. The battery voltage is below 17V
 2. The charging current after 24 hours of charge is not below 100 mA. That is, if the battery voltage cannot be sufficiently high.
- Within the framework of the service, the batteries have to be replaced after the specified **maximum 4-year** operating period or if the voltage drops below 17V.

Dispose of used batteries according to the National regulation.

CAUTION: RISK OF EXPLOSION IF BATTERIES ARE REPLACED BY AN INCORRECT TYPE.

We recommend that the software of the panel is updated during the annual maintenance check!

The expected minimum lifetime for the FlexiSmoke™ is 10 years excluding the batteries, see above.

CAUTION: Disconnect Pyrotechnic gas generator cables prior to doing any maintenance work to prevent activation by mistake. Remember to connect the device again when maintenance is concluded.

23.1 Maintenance agreements

Be aware that regular inspection of smoke ventilation systems is a legal requirement. The legislation requires that the smoke ventilation system's owner inspects and tests the system once every year.

WindowMaster offer maintenance agreements for the smoke ventilation system and every year we inspect the complete system to ensure it complies with the applicable legislation. Maintenance of the smoke ventilation system includes checking windows, window actuators and emergency power and checking that triggering and control functions are fully functional.

Contact our service department for further information: **telephone +44 1536 614 070 or info@windowmaster.co.uk**

23.2 Replacement modules

23.2.1 Replacement of 5PS, 5IO and 5UM modules

1. Disconnect the 230 V and the batteries.
2. Wait until the display has completely turned off before removing the module.
3. Insert the replacement module.
4. Turn on the 230 V and connect the batteries.
5. The system will be ready again after approx. 2 seconds.

23.2.2 Replacement of 5MC module

1. Save a backup of the configuration on a USB stick (recommended) or the build in SD-Card and make a note of the CAN-address, if necessary please see section 14.16 or 14.17.
2. Disconnect the 230 V and the batteries.
3. Wait until the display has completely turned off before removing the module.
4. Insert the 5MC replacement module.
5. Insert the USB stick or the SD-card from the old 5MC module into the new module.
6. Turn on the 230 V and connect the batteries.
7. Enter the CAN-address
8. Load the parameters from the USB stick / SD card.
9. The system will be ready again after approx. 2 seconds.

If the 5MC module, which is to be replaced, is completely without function then do straight to point 2.

If there is no backup of the configurations, these are to be entered manually.

It is therefore recommended to take a backup, on a USB stick (recommended) or on the built in SD card, when the panel is running, if necessary please see section 14.16 or 14.17.

24 Declaration of Conformity and CE certificate

The smoke ventilation panels are manufactured and tested accordingly to the European requirements.

The total system is not to be put into service until a declaration of conformity for the total system has been made.

The "Declaration of Conformity" and the EN certificate are supplied with panel as separate documents.
